

Wasrag Technology Series

# Guidelines for Planning Sustainable Sanitation Projects and Selecting Appropriate Technologies

03/20/2019

Water and Sanitation Rotarian Action Group

Version: Final



This document was developed by the Water and Sanitation Rotarian Action Group. This Rotarian Action Group operates in accordance with Rotary International policy, but is not an agency of, or controlled by, Rotary International or The Rotary Foundation.

This document is for informational purposes only. Neither the Water and Sanitation Rotarian Action Group, nor Rotary International nor The Rotary Foundation endorses any particular technology, methodology or company. Any reliance upon any advice, opinion, statement, or other information displayed in this document is at your sole risk.

## Table of Contents

<b>INTRODUCTION.....</b>	<b>2</b>
A GUIDE TO SELECTING A SUSTAINABLE WATER, SANITATION, HEALTH & HYGIENE PROJECT SYSTEMS.....	2
PLANNING FOR SUSTAINABILITY.....	2
DOING MORE WITH THE SAME RESOURCES.....	3
USING THIS E-LEARNING DOCUMENT FOR PLANNING & BUILDING SUSTAINABLE PROJECTS.....	4
<b>WHAT IS SUSTAINABLE SANITATION ALL ABOUT? .....</b>	<b>5</b>
SITE CONSIDERATIONS OF SUSTAINABLE SANITATION.....	5
<b>PROJECT PLANNING .....</b>	<b>7</b>
INTRODUCTION.....	7
STEP 1. CLASSIFY THE SITE TO ASSIST WITH TECHNOLOGY SELECTION.....	7
STEP 2. IMPLEMENTING SANITATION EDUCATION.....	9
STEP 3. IDENTIFY ON-SITE CULTURAL AND ENVIRONMENTAL PARAMETERS.....	11
Determine Cultural Practices.....	11
Determine Climatic Conditions.....	12
Determine Water Table Effect.....	12
Determine Water Access.....	13
Determine Soil Types.....	13
Using Bio-solids for Agricultural.....	13
STEP 4. SELECT THE MOST APPROPRIATE SANITATION TECHNOLOGY AND PRACTICE.....	14
<b>ECOLOGICAL SANITATION TECHNOLOGIES.....</b>	<b>15</b>
INTRODUCTION.....	15
PIT LATRINES.....	15
VENTILATED IMPROVED PIT.....	16
KUMASI VENTILATED-IMPROVED PIT.....	17
REED ODORLESS EARTH CLOSET.....	18
COMPOSTING TOILETS.....	18
URINE DIVERSION DEHYDRATION TOILETS.....	20
AMILA 3 BIOFILTER TOILET SYSTEM.....	24
ANAEROBIC BIO-DIGESTER REACTOR.....	25
ANAEROBIC BAFFLED REACTOR.....	28
FOSSA ALTERNA.....	28
ARBORLOO.....	30
TWIN PITS FOR POUR FLUSH.....	30
MICRO-FLUSH TOILET.....	32
DECENTRALIZED WASTEWATER TREATMENT SYSTEMS.....	32
SEPTIC TANKS, LEACH FIELDS AND WETLANDS.....	33
<b>WASTE HANDLING AND APPLICATION .....</b>	<b>36</b>
URINE APPLICATION.....	36
FECES HANDLING AND APPLICATION.....	37
<b>ECOLOGICAL SANITATION TECHNOLOGIES PROS AND CONS.....</b>	<b>38</b>
<b>LINKS TO HELPFUL SANITATION TECHNOLOGY WEBSITES .....</b>	<b>0</b>
SANITATION GUIDELINES.....	0
DRY SANITATION TECHNICAL WEBSITES.....	0
POUR FLUSH SANITATION TECHNICAL WEBSITES.....	1
<b>CHECKLIST FOR INSTALLATION OF SANITATION FACILITIES .....</b>	<b>2</b>
PLANNING UNDERSTANDING THE AREA/COMMUNITY.....	2
IMPLEMENTING A PROGRAM THROUGH EDUCATION.....	2
ENVIRONMENTAL CONSIDERATIONS - WATER AVAILABILITY AND USE.....	3
ENVIRONMENTAL CONSIDERATIONS – FLOODING AND ITS EFFECT ON TECHNOLOGIES.....	3
SELECTING THE ECOLOGICAL SANITATION TECHNOLOGY.....	3

# INTRODUCTION

## A Guide to Selecting a Sustainable Water, Sanitation, Health & Hygiene Project Systems

A safe and reliable drinking water and access to adequate sanitation is not available to nearly one billion people. Rotary International has recognized this problem and has made it one of the six areas of focus for its new grant model.

Bringing safe and reliable drinking water to the developing world has been a challenge to Rotary clubs and other non-governmental organizations (NGOs), with the result that an estimated fifty percent of all water projects built by these organizations have failed within five years of being built. This high level of failures can be attributed to many factors, including:

- Selection of inappropriate technologies
- The Myth: “Just built it and it will work forever.”
- Poor water point siting
- Lack of on-going operations and maintenance training
- Lack of spare parts
- Poor or changing water quality
- Vandalism, theft, or conflict
- Lack of finance for operations and maintenance
- Ineffective community water committees
- Weak follow-up and project supervision by project sponsors
- No long-term project monitoring and evaluation

Rotary International, The Rotary Foundation and Wasrag have initiated a pilot program that is designed to change this failure rate. The one-year pilot program, Project Enhancement Process (PEP), was initiated in nine districts in July 2012.

### Planning for Sustainability

With over one billion people without safe drinking water and over two billion without adequate sanitation facilities, the challenge of providing everyone with safe drinking water and proper sanitation is daunting. With 34,000 Rotary clubs in the world, the number of projects that would be required to make a difference will require all of the Rotarians to work together with partner organizations, host country governments, and village leaders with a new approach to WASH projects.

The goal is that Rotarians plan, design and complete water and sanitation projects that remain functional and that are maintained by the village water committees throughout their intended lives. Just as Rotary continues to seek to totally eradicate Polio in the world, we must seek to build sustainable projects that will continue to be fully functional for ten or more years of operation that must be incorporated into the system plan for serving the village.

To Wasrag, a sustainable project means “Meeting the needs of the present without compromising the ability of future generations to meet their needs.” The Rotary Foundation’s sustainability principles can be found at: <https://my.rotary.org/en/document/global-outlook-series-guide-sustainability>. Critical to creating sustainable projects is that Rotary clubs integrate their local project into a regional planning effort lead by the village leaders, host country Rotarians, and active in-country NGO, with the support from the governments and international Rotary club sponsors.

The following steps are designed to help Rotary clubs achieve sustainable projects:

- 1) Identifying potential alliances in the host country to support the leadership and assist in monitoring and evaluating successful operation of the installed system
- 2) Ensuring community ownership and to demonstrate self-sufficiency in operation

- 3) Focusing on needs, the current state of the community, the desired future (such as access to clean water year-round and reduction in water-borne diseases) and an assessment of technical, socio/cultural and financial risks affecting the likely long-term viability of the project,
- 4) Involving women in the initial design of the system and in ensuring that the system is maintained and associated hygiene and behavioral changes take place.,
- 5) Choosing appropriate technologies are installed and operational support is available, and
- 6) Focusing on the overall community goals of a healthy and economically stable future is planned for.

The three-part approach that the PEP Pilot is testing includes:

1. Formation of a Country Regional Team or Water, Sanitation, Health & Hygiene Committee that provides the in-country priorities and overall guidance of a phased program;
2. Develop a Program Planning and Performance Team (PPP, also known as Rotary Service Corps) that assists the Regional Team and village leaders in completing a needs assessment and conduct an Alternative Analysis of the best technical and operational solution
3. Use of the Wasrag Technical Guidelines and in-country support system to achieve the Sustainable System that meets the jointly defined village needs for WASH.

This PEP Pilot is seeking to support a program that will over time provide WASH services for 100 percent coverage of all of the villages in each country/RI District. This approach helps create a shared support system designed to enable a health and hygiene program and an operator/water and sanitation committee training program for the project service area that will be sustained.

The regional approach may also provide for increased efficiency and use of shared facilities and operational support systems to serve a larger number of villagers at a lower unit cost. When the provision of one project at a time is done in rural areas and in isolation from the larger district, the higher cost of overhead management, training, monitoring and support for the maintenance of the facilities reduces the time and resources available to do the next project. This also contributes to the probability of a higher project failure rate within the first five years.

## Doing More with the Same Resources

With over two billion people needing help with developing safe drinking water and basic sanitation, service organizations cannot afford to approach this challenge in an ineffective way. Even though Rotary has a finite number of volunteers and financial resources, it has a history and reputation of applying good management principles and business practices to its humanitarian endeavors. The PEP Pilot is undertaking steps to obtain a greater efficiency and effectiveness through a coordinated approach of the host and international Rotary clubs working in the same country along with the in-country NGO and governments in partnerships as a normal course of action and a centralized Rotary (Wasrag) management and support structure.

The strategic partnerships with organizations with a shared vision of sustainable projects, will allow for an approach to completing needs assessments on a country-by-country or region-by-region basis. This needs assessment will focus on a shared action plan to design, fund, and implement water and sanitation systems with 100 percent coverage of the priority areas, which will leverage the limited resources of organizations that have a shared goal of providing safe water and basic sanitation systems on a sustainable basis. This approach is built into the PEP Pilot that began in July 2012.

## Using this E-Learning Document for Planning & Building Sustainable Projects

The Wasrag Technical Guideline—*Guidelines for Planning Sustainable Sanitation Projects and Selecting Appropriate Technologies* (and its companion guidelines, *Guidelines for Planning Sustainable Water Projects and Selecting Appropriate Technologies*, and *Guidelines for Selection Sustainable Health and Hygiene Programs*) is the first step in this new e-learning program. This document reviews how to—

- evaluate sources of water supply
- evaluate water quality
- evaluate and select appropriate treatment technologies
- plan and construct a project
- monitor performance of the constructed project

The document is designed for Rotarians with basic levels of understanding of water issues, yet it will lead the reader to advanced levels of system design and operation.

After participating in this e-learning program, participants will have access to the Water and Sanitation Rotarian Action Group (Wasrag) technical experts through their “Ask an Expert” program. The participants have personal access to someone with long professional experience with the issue in question.

## WHAT IS SUSTAINABLE SANITATION ALL ABOUT?

The main objective of a sustainable sanitation system is to protect and promote human health by providing a clean environment which breaks the cycle of disease. A sustainable sanitation system must be economically viable, socially acceptable, technically and institutionally appropriate and be capable of being managed to provide protection to the environment and natural resources.

Ecological sanitation, as defined by Tilley in the *WS&SCC/Eawag Compendium of Sanitation Systems and Technologies*, “applies to waste treatment technologies when they not only limit the spread of disease, but protect the environment and return nutrients to the soil in a beneficial way.” (reference [AKVO.org](http://AKVO.org)).

Many ecological technologies require human waste to be **treated on site**, as opposed to the centralized water transporting systems that have been installed over the last century or so in large cities across the globe. Due to current and projected major shortages of water, studies are in progress through a number of projects financed by the Bill and Melinda Gates Foundation and others, to find innovative solutions which can replace some of these centralized technologies in future urban expansions. Wasrag will monitor the progress of these studies, and when appropriate, bring them to the attention of Rotarians who are conducting sanitation projects.

### Site Considerations of Sustainable Sanitation

The focus of this document is on sustainable sanitation technologies that can be used while being maintained, that do not require relocation when filled to capacity, and do not depend on unsustainable water supplies.

Selection of the most appropriate sustainable sanitation treatment for a region or country is dependent upon:

1. Government policies which may/may not consider sustainable technologies
2. Cultural aspects, open defecation and any restrictions of working and/or eating foods fertilized with human urine and treated feces
3. Climate
4. Geography and terrain
5. Soil porosity
6. Water availability
7. Depth to ground water, local flooding
8. Location of facility
9. Agricultural activity
10. Ability of population to accept, cooperate and agree to ongoing use and maintenance

Many NGOs donate latrine toilets, mainly due to their low initial capital costs. While these are seen by some to be at the bottom “step on the ladder” of suitable facilities, their continuing use is being called into question because of growing concern about long term pollution of underground water supplies. Like some wastewater treatment with a “flush and forget attitude,” the latrine is now starting to be looked upon as a “fill and forget” technology. Conversely, with several latrine installations, the original sanitation goal has been subverted by the fact that the new latrine, being of sound construction, is put to an entirely different use as a grain or other product storage unit.

Sanitation marketing and micro financing can be used to assist people in paying for all or a large proportion of a toilet and/ or undertake part of its construction, which helps guarantee ownership, ongoing use and ongoing maintenance. Some NGOs are saying “*you have to be on site for 2 or 3 years to make sure that people continue to use and maintain the sanitation facility you install.*”

Arid regions with very little or no water will best be served with dry toilets, as will some tropical climates where water dries up before the dry season ends. Regions where the depth of water tables start off high and decline towards the end of the dry season should also consider dry systems. To

avoid pollution and spreading of diseases, maintenance of minimum clearance distances above water tables and from water resources cannot be over-emphasized.

# PROJECT PLANNING

## Introduction

Sustainable project planning uses a 4-step analytical system to assist choosing the most suitable sanitation technology, given the project location and aforementioned factors:

**Step 1.** Classify the site using the descriptions below. Classification will help match the most suitable technology with the environment and demography of the target area.

**Step 2.** Engage with the community. Work to understand how the community under consideration lives. Get answers to questions such as:

- What governmental agency, if any, regulates sanitation in the area?
- Is there a sanitation policy in place with an established program?
- What existing water and sanitation practices are in place?
- Is the community generally healthy?
- What hygiene practices are generally used following urination and defecation?
- What can you learn from local infant and child mortality, disease rates and causes?
- Is information about sanitary related disease and mortality available?
- Is open defecation commonly practiced in the area?
- Has a Community Led Total Sanitation (CLTS) or similar sanitation awareness program been introduced in the community? If so, how is it progressing? Read about CLTS from sites designated later in the Guide.
- Talk to central and regional government agencies about the CLTS program and ascertain how and who implements it.
- How can Rotary help improve sanitation conditions in the community?

**This step may involve dealing with centuries-old habits**, like defecating and urinating in fields, around villages and streams in which people swim and which are used as a water supply. These may be normal living habits of the people in the community you want to help.

**Step 3.** Understand how local cultural and environmental issues affect the best selection of a sustainable technology. This step should always be with the community as partners so that they will be more likely to accept and adopt new programs. Get answers to questions like:

- What and where are the local drinking water sources?
- How deep is the local water table?
- What is the seasonal variability of local and regional water sources?
- Is there sufficient water available for sanitation all year?
- What are other geological factors, soil types, topography, etc.?
- Are there local food and water taboos, myths, preconceptions of agriculture?

This step will help understand if the local population has preconceptions about how their food is grown and if they would resist the idea of eating food fertilized by human waste. It will also identify resistance to adoption of technologies which would allow urine to be separated for use as a crop fertilizer, and the use of dehydrated feces or compost as a soil enhancement. Note: Studies have found this is technically not a problem, but some people have preconceived ideas that it is.

**STEP 4.** Use the above information to compile a list of suitable technologies and select the most appropriate. Don't forget to have a look at the Ecological table of Pros and Cons of the Technologies near the end of this Guideline, as it gives a quick guide to differences between them.

## Step 1. Classify the Site to Assist with Technology Selection

The first step entails classifying the site into types defined by size, population, and organization.

### 1. Household

A household is defined as allotments having an area from ¼ to 1 hectare (Ha) in area, predominantly used for housing only, and from which no income is derived. Household demographics can extend from infants to elderly. Population numbers and age information



determines the size of fecal vaults and latrine pits. Fecal matter accumulates on average at about 50 liters (L) per person per year but could increase to 80L with dry cleansing materials. Each household would own and be responsible for the management of the installed unit, which should involve the owner in providing on-site construction and the purchase of some or all components.

**Most suitable technologies:** Arborloo, UDDT, Fossa Alterna, Twin Pits for Pour Flush, Composting Toilet

## **2. Neighborhood**

A neighborhood is defined as adjacent allotments with communal facilities/institutions and include densely populated slum settlements which will most likely necessitate the installation of a multi-pan/cubicle facility due to existing cramped occupational conditions. Such installation will be affected by the site's area and services, availability of water, how and who will be responsible for the charges required to cover ongoing maintenance and cleaning costs.

**Most suitable technologies:** Septic Tank, UDDT's, Anaerobic Digester, Biogas Digester, Twin Pits for Pour Flush

## **3. Peri Urban**

Comprised of larger, outer allotments (1Ha and greater) of an urbanized area which may be attached or separate but close to the main town. Selected Technologies where flooding does not occur and where the ground water is maintained at a depth of at least 2 meters below the bottom of the facility can be considered. Education and monitoring of the toilet use together with the collection, storage, dilution and application of urine to plants and ultimately adding any treated feces to the soil will need to be undertaken and regularly monitored for most likely at least one year.

**Most suitable technologies:** Septic Tank, UDDT, Biogas Digester, Twin Pits for Pour Flush, Composting Toilet, Fossa Alterna, Arborloo.

## **4. School**

These are usually one-off projects, consisting of a building or compound used for educating children above preschool age. They are most suitable for Rotary Clubs to provide using local labor and materials wherever possible.

Although some higher ratios for school toilets have been used, for example, 1:24 girls and 1:35 boys in Kenya, the WHO requirements are most adequate. Female urinals may be substituted for some pans. A high instance of girls staying at home during menstruating occurs because of the lack of privacy in school toilets and this requires urgent addressing at most schools. Consider upgrading some toilets if this is found to be occurring.

A health and hygiene regime is the cheapest and easiest first stage of introducing sanitation into a school and the community that has no sanitation facilities and which practices open defecation. While the training of students in the correct use and cleaning of school toilets will contribute tremendously in their use and ongoing maintenance this could be extended both at school and in the home. It would be beneficial to have teachers meet with leaders and influential women of the community and for them to introduce a training program on toilet use and etiquette along with instructional flyers (as has been produced in Javanese schools for hand washing). Teachers can also provide training at school for parents in after school parent classes. A student Toilet committee should also be involved with teachers in toilet planning and training children in the correct use of toilets. Toilets should be provided to the following minimum requirements:

1. The World Health Organization (WHO) ratio of 1:50 children,
2. Preferably provide two female pans for each male pan/urinal
3. Minimum internal cubicle dimensions of 90cm (36 inches) width by 150cm (60 inches) in length fitted with a privacy door having a 150mm (6-inch) open space top and bottom to assist with air circulation. In hot climates provide openings in the upper walls to reduce internal temperatures.
4. Dry sanitation toilets (e.g., UDDT) should be installed where water cannot be guaranteed all year round. Latrine pit or Ventilated Improved Pit (VIP) latrines must not be installed.

5. Female Toilets must be fitted with a wash basin and small bench to facilitate full privacy for girls during menstruation.
6. A concrete or other hard surface floor should be provided to assist with maintenance cleaning.
7. Urinals can be substituted in boy/male toilets on a ratio of about 5 urinals for each required sit/squat pan cubicle.
8. Provide hand washing basins/troughs at the ratio of one to each three toilets with soap (sand and/or ashes are equally alternative if soap is unavailable) and water, including hand drying, together with training and management of the toilets prior to handover.
9. The formation of a student toilet committee is strongly supported in the planning, design and construction of school toilets as well as providing training to other students in the school.
10. Consider providing (the Sustainable Sanitation Alliance has reported successful use of) unisex cubicles for children up to 9 years of age.
11. Facilities must include provisions for anal or dry cleaning.

**Most Suitable technologies:** Septic Tank with Leach Field or Constructed Wetland, UDDT's, Biogas Digester, Twin Pits for Pour Flush, Composting Toilets, Fossa Alterna, Arborloo.

### **5. Community Facilities/Institutions**

These facilities comprise public toilets and toilets in community centers, halls and the like. The number of fixtures for females and males may be subject to local regulation, but provision on the ratio of two female to one male toilet is desirable due to the difference in time of body functions and clothing. Urinals/cubicles for both males and females should be the same as for schools, unless directed by local regulation. Cubicles for disabled people, where provided, should be rectangular in plan with a minimum circulation space of 1.6m (63") by 2.0m (79") for use by either gender. Toilet facilities in halls and the like may require accessibility from within the building and be subject to regulation by governing authorities.

**Most Suitable Technologies:** Septic Tank with Leach Field or Constructed Wetland, UDDT's, Biogas Digester, Twin Pits for Pour Flush, Composting Toilets, Fossa Alterna, Arborloo.

## **Step 2. Implementing Sanitation Education**

Without community buy-in starting with the planning stage, the project may be destined to failure. The following education systems are tried and tested methods for engaging the community in a sanitation project. Ascertain if there is a role for Rotary; what it might be and what Rotary should do to further complement any existing program, or should it commence its own program in conjunction with the government.

**Community Led Total Sanitation (CLTS).** CLTS is a highly successful sanitation *education* system used in over 50 countries, but it requires accredited and trained facilitators to engage with the target population. Such education programs are the first stage of moving from an open defecation to an open defecation free area. WaterAid also has a program with defined steps which must be followed in the process. Investigate and ascertain answers to the following questions:

- Should a CLTS program (Community) and/or a SLTS (School) be undertaken?
- Are there CLTS Trainers available and if so, how are they contacted?
- Can a Rotarian be trained to be a CLTS specialist?
- Are there alternative ways of engaging the local population?

It is necessary to check whether open defecation is practiced and to ascertain through local Rotary Clubs or other NGO's as to the current situation. Endeavour to ascertain if and which government agency has taken steps to implement a CLTS or other sanitation education program

within the region or village and if it has another agency or NGO Involved. What program(s) has been introduced, how is it implemented and which agency or NGO is implementing it? It may be necessary to talk to, negotiate and collaborate with the agencies to develop a partnership. Ascertain government and agency/NGO Involvement to the following questions:

- Are there any sanitation programs being undertaken by a government agency?
- Is an NGO or other agency implementing a sanitation program?
- Has the government listed any particular technology in a policy or publication?

After establishing the need to implement sanitation program a decision needs to be made on which program to use. If a CLTS program is to be used it will be necessary to either obtain the services of a CLTS trained facilitator to organize and implement an education program, or select a project team member to be trained. A Handbook is available in 6 different languages by CLTS at: <http://www.communityledtotalsanitation.org/resource/handbook-community-led-total-sanitation>. Additionally, a Portuguese copy can be obtained from UNICEF Mozambique; a Khmer copy from Plan Cambodia and an Arabic translation is currently under way. A “Trainers Training Guide” is also available at: <http://www.communityledtotalsanitation.org/resource/facilitating-hands-training-workshops-clts-trainers-training-guide>.

The Sequence of Steps for triggering CLTS is briefly:

1. Introduction and Rapport Building
2. Participatory Analysis
3. Ignition Moment
4. Action Planning by Community
5. Follow Up

Refer to: “A Practical Guide to Triggering CLTS” at:

<http://www.communityledtotalsanitation.org/page/clts-approach>.

**WaterAid.** The WaterAid 10-step process is an alternative to CLTS. More can be learned about this program by watching their video at:

[http://www.wateraid.org/uk/about\\_us/newsroom/6613.asp#watch](http://www.wateraid.org/uk/about_us/newsroom/6613.asp#watch).

Following the CLTS training, Sanitation Marketing should be implemented by introducing the technology and models best suited for the environmental and existing cultural conditions available along with costs. An Introductory Guide Sanitation Marketing – WSP can be viewed at:

<https://www.wsp.org/library?page=0>.

A Micro loan system should be considered to assist those with very low incomes with the purchase of toilet componentry along with clear information on what is being offered and what is required of the purchaser. It is not uncommon for the purchaser to install the base structure and the toilet surround. Some cultures will not eat food fertilized with human biomass or will not work with it. This issue needs careful consideration and discussion when planning a sanitation solution (particularly when considering UDDT and composting toilets).

**Sanitation Marketing.** While the Millennium Development Goals for improved water supply for 2015 were met in 2010, sanitation goals at that stage were at least 10% behind the required growth rate, which means that the goal of 50% reduction by 2015 is now expected to extend to 2026.

However, Sanitation marketing has greatly contributed to what has been achieved so far. Some say that SM is the only sustainable way to meet the desired goal. While many people continue to want their own toilet, many do not achieve it for various reasons including a lack of ability to repay finance loans and sometimes because their landlords consider that such toilets are unnecessary and do not provide them, as they are not compelled to do so.

Toilets are considered more essential for women and children, but investment decisions are mostly made by men and this can also be a factor in why the target is well below. People's desire to have their own toilets may also be dampened by stories emanating from others who may have had unpleasant experiences. Research in sanitation marketing strongly suggests that people want a toilet for a number of reasons other than improving health reasons, for example, better to have one for visitors; guarantees privacy for the family; reduces chance of being attacked by vermin and wild animals.

A large number of NGOs and the like are offering by donation with little choice. Donating toilets with subsidies by governments and NGOs has brought limited success. It has seen inferior products and installations delivered quite often due the limit of the total donation amount. While Toilets can be "given" to school programs all efforts should be made to avoid giving toilets to villages and households. Community and school toilets need to be locked into a cleaning, maintenance and hygiene program before handover including an unscheduled monitoring program to ensure they are being used and correctly maintained.

How we introduce toilets into the community may well dictate either a favorable or non-favorable response from the community we are targeting. Various tools should be considered including using school toilets to make parents aware of why they should consider a home toilet along with offering favorable purchase terms particularly those in rural areas who live below the poverty line.

### **Step 3. Identify On-Site Cultural and Environmental Parameters**

#### **Determine Cultural Practices**

**Open Defecation.** The practice of openly defecating and discharging urine anywhere in the open is widely practiced in many developing countries of the African, Indian and Asian continents, particularly in rural and semi-rural areas. While some communal toilets are provided in slum areas, they are generally short of the numbers required to serve the population and are inconveniently located by both position and distance. The same open practices occur in the rural rice fields, on tracks, roads and the like. It is a practice that is millennia old, and many do not understand that this, together with the non-washing of hands, is the cause of the high rate of illnesses and death from diarrhea (5,000 children per day under 5 years of age) and cholera. Ask the following questions to gain an understanding of what is happening in the Community/school:

- What are the existing sanitation practices?
- Is open defecation practiced anywhere in the community?
- Is defecation practiced in a defined location?
- Are there any toilets in the area?
- Are there any toilets in the community that people have access to?
- Are there any community toilets in the area?
- Are there any toilets at the school?
- Are there any illnesses or diseases caused through the lack of sanitation facilities?
- Have there been any child deaths from diarrhea?

**Managing Urine and Feces.** Some ecological sanitation technologies require urine and feces to be collected separately and stored for use as a fertilizer and/or soil amendment. Working with feces may be foreign to some community cultures and as a result unless detailed education and management training on these issues are provided, both the toilet and the potential benefit of fertilization and soil amendment will fail. Urine can be used as a fertilizer almost immediately while feces require a longer period in a warm dark chamber to kill off pathogens. Cultural opposition may, however, continue to ferment. See also notes on UDDT's and Composting Toilets. Ascertain answers to:

- Has the local community used urine and feces as fertilizer of locally grown crops?
- Apart from rice are other vegetables and fruit grown in the area?

## Determine Climatic Conditions

**Arid Dry Areas.** In areas where water is scarce, dry toilets are more suited, and lower (deeper) water tables allow the construction of deeper latrines. However, the greater the depth the harder it is to remove any feces because it becomes compacted under its own weight and difficult to empty. As a result, once pits are filled, new pits need to be built and the latrine structure moved. There are instances where this has reached a crisis point with some schools, community facilities and household sites having insufficient land for further pits.

Urine diversion dehydration toilets (UDDT) are most suitable for arid areas, particularly where urine can be diverted for plant fertilization and feces can be used as a soil amendment. Feces require storage in a dark chamber built at ground level for not less than 6 to 12 months so that pathogens are killed before the material can be handled safely.

**Sub-tropical/tropical Areas.** These areas are more suited to pour flush (or wet) toilet systems because of the availability of water. However, some areas which are subjected to very wet seasons can still be devoid of water towards the end of the dry season thereby making the Pour Flush toilet redundant and unusable. It is imperative that rain water and/or ground water availability be investigated early, and its effect taken into account in reaching a decision of which technology to implement. Like arid areas, the desire to separate wastes for plant fertilization and soil improvement needs to be considered in deciding whether to adopt pour flush or dry toilets.

**Temperature.** Warm to hot temperatures speed up feces enhancement, killing pathogens in 6 to 8 months (whereas in colder climates below 25° Celsius, composting doesn't work as well as biogas reactors). Placing UDDTs and composting units under houses where space is available enhances the composting process, as does painting the access panels black. The local effects of temperature should be understood before deciding which technology to install. More ventilation is required in the toilet surround in hot climates.

**Rainfall.** Rainfall increases flows in streams and rivers and causes lake levels to rise. Streams and lakes reach their maximum areas and depths during the wet season. More water is available for percolation into the ground in the wet season, which causes the ground water table to rise. Surface water and ground water levels drop during the dry season. Keeping adequate depth between the bottom of the toilet pit and the ground water table is important, as is keeping the toilet out of the reach of flood waters. Obtaining rainfall and water level information is imperative before making any decision on the suitability of sanitation technology. Determine the following:

- Does the area have a reliable year-round water supply?
- What is the source of the water supply?
- What systems (rainwater harvesting, water well, spring water) are used to maintain the water supply?

Is water required to flush toilet pans and perform anal cleansing?

## Determine Water Table Effect

**Water Table.** Surface waters percolate underground to the water table, where it slowly travels over long distances, taking with it any polluting human wastes (such as nitrates) and chemicals (such as arsenic and pesticides). Streams and lakes reach their maximum areas and depths during the wet season, thereby providing higher water tables beneath them. As surface water levels drop, so does the underlying water table. At least 2 meters of soil (more is better) must be maintained above the highest water table level to the base of any technology which allows urine and feces to leach into the surrounding soil such as the Latrines, Arborloo and the Fossa Alterna; see diagram on p 119 of: [http://hesperian.org/wp-content/uploads/pdf/en\\_cgeh\\_2012/en\\_cgeh\\_2012\\_07.pdf](http://hesperian.org/wp-content/uploads/pdf/en_cgeh_2012/en_cgeh_2012_07.pdf)

**Most Suitable Technologies:** Biogas Reactors, Composting Toilets and UDDTs because they can be sealed from high and variable water tables.

## Determine Water Access

**Water Distance.** No ecological sanitation technology which allows waste to seep into adjacent soils should be placed within 30 meters of any water source - including streams, lakes and water wells. See also diagram page 119 at above link.

**Quality.** Water quality can vary in streams and lakes between wet and dry seasons depending upon the amount of human activities and what is deposited. At the end of the wet season when water tables are high and where flooding occurs, discharge from Arborloos, Fossa Alternas, pour flush and septic tanks increase the chance of pollution of surface water supplies and underlying ground water sources if incorrectly located.

**Flooding Depth.** The depth and duration of flooding must be established to assist in determining the most suitable technology to install in these areas. Flood levels may vary over the area under consideration due to varying topographies, terrain and vegetation covers. Flooding of dry and wet VIP latrines, fossa alternas and other pit-type latrine toilets allows urine and feces to escape increasing the e coli count and pathogens of a water source, which can lead to the spread of diarrhea and cholera. Toilet pans must be installed above the locally accepted flood level to prevent flood waters accessing fecal chambers and allowing the waste to mix with flood waters. Urine however will not increase e-coli if discharged to water sources. Determine answers to the following:

- The areas covered by flood waters?
- What is the maximum depth of the flood waters at end of wet and dry seasons for the areas under consideration?

**Most Suitable Technologies** for areas subject to flooding are Biogas Reactors, Composting Toilets and UDDTs because they can be sealed from flood waters.

**Flooding Frequency and Duration.** Flooding quite often occurs on an annual basis in the river deltas of the developing countries of Bangladesh, Cambodia, Vietnam, India and Nigeria and this affects settlement patterns, including the location and type of sanitation technology. Frequent flooding of an area must be given consideration during the planning of a sanitation system, as regular flooding will render some ecological sanitation units useless for considerable time until after the flood has abated. Latrines and other toilets with in-ground unsealed pits located below the flood waters allow the feces to disperse thereby polluting water and making the surrounding area dangerous to humans. Flood levels need to be determined so that the squat pan is set higher to avoid flows into the feces storage vaults which must have sealed access panels.

## Determine Soil Types

**Rock.** Ecological sanitation technologies, such as UDDTs that do not rely on ground pits or in-ground pipes, can be built in rock or on rocky surfaces. Latrines installed in rock are capable of polluting adjacent water supplies as wastes may percolate into rock fissures and spread to nearby water sources.

**Compacted Clays.** These materials have an advantage where the water table is very low as they allow very deep latrine pits to be excavated. While depth prolongs the usefulness of the latrine, it increases the costs and difficulties to remove wastes, since its density increases due to compaction. The extra depth also necessitates the use of mechanical vacuum pumps, which are both expensive and rare in developing countries.

**Friable Loams and Sand.** These materials, while favoring excavation, allow waste from latrines and pour flush pits to more easily absorb into the surrounding soil and to disperse over a larger area. In many river delta areas they also assist in carrying waste further, which can lead to increased pollution of streams. Sand is generally carried by faster flowing waters, so care needs to be taken in deciding on the most suitable sanitation technology to use in river deltas. Septic tank irrigation systems (leach fields) should be kept well clear of these situations.

## Using Bio-solids for Agricultural

**Trees and food crops.** Individual trees (for example, mangoes) and food crops can benefit from the regular application of urine (diluted about 5:1) collected from UDDTs and other similar urine

separating sanitation technologies. Because of its high nitrogen content, urine can be used by local farmers to improve their crops, and at the same time provide a small increase in household income. When stored, the container should be capped to prevent contamination by air, which can bring on early deterioration of the urine. Feces covered with ashes, sand or soil to absorb any moisture can be worked, after which it can be used as a soil conditioner or, if properly composted, can be used as a fertilizer in the same manner as urine with both materials attracting payment from farmers. UDDTs at schools quite often use ashes or soil supplied by students.

**Animal Husbandry.** Concentrated products rich in organic material, which can include animal manure and biodegradable organic waste, can be combined with human waste in Biogas Digesters, thereby increasing the output from animal sources-

#### **Step 4. Select the Most Appropriate Sanitation Technology and Practice**

Once the critical information collected in steps 1, 2, and 3, above, has been compiled, selection of the most appropriate ecological sanitation technology can be undertaken. In the following sections, each technology will be discussed. At the end of this guideline, the table titled, “Ecological Sanitation Technologies Pros and Cons” provides a list of the various technologies discussed herein and compares them using the critical siting factors discussed in the first three steps. Once armed with this information, the reader is encouraged to discuss the pros and cons of several alternatives with leaders in the community so that early buy-in of the program is encouraged.



*EcoSan latrine completed at Buyijja, Uganda*



*Trained latrine builder in Sichiyanda village, Zambia, shows off her newest latrine.*

## ECOLOGICAL SANITATION TECHNOLOGIES

### Introduction

Over the years, ecological sanitation technologies have evolved from the simple pit latrine to more sophisticated systems that can withstand the ravages of flooding, limit pollution to the surrounding ground and water supplies, and provide safe and reliable fertilizers and soil amendments. In the following sections the various technologies that Wasrag feels can be used in appropriate settings are discussed. The reader is reminded that no one sanitation technology is “best.” Each has its place as customs and environmental conditions dictate. Each of these technologies are compared in the section titled, “Ecological Sanitation Technologies Pros and Cons.” If the reader has read this guideline, has a good understanding of the available technologies, and is still uncertain as to which technology is the most appropriate for their project, Wasrag offers the “Ask an Expert” program in which a Rotarian with professional experience in sanitation technologies will provide real-time consulting. The “Ask an Expert” program can be accessed through Wasrag’s website: <https://www.wasrag.org/305536/Page/Show?ClassCode=Page&Slug=technical>.

### Pit Latrines

Pit latrines are one of the most widely used sanitation technologies around the world. Excreta as well as anal cleansing materials are deposited into a pit. As the pit fills, leaching and degradation limit the rate of accumulation. Urine and water percolate into the soil through the bottom of the pit, while microbial action degrades the organic portion. When the pit is filled, it needs to be emptied or closed and relocated. The frequency of emptying is dependent upon how deep the pit is dug.

If the pit latrine is to be reused it should be lined. Lining the pit also provides support to the superstructure and prevents the pit from collapsing. Lining materials can include brick, rot-resistant timber, concrete, stones, or mortar plastered on the soil. The bottom of the pit should remain unlined to allow for infiltration of liquids from the pit into the soil. Information about pit latrines can be found at: [https://akvopedia.org/wiki/Single\\_Pit](https://akvopedia.org/wiki/Single_Pit) & <https://sswm.info/node/8237> &



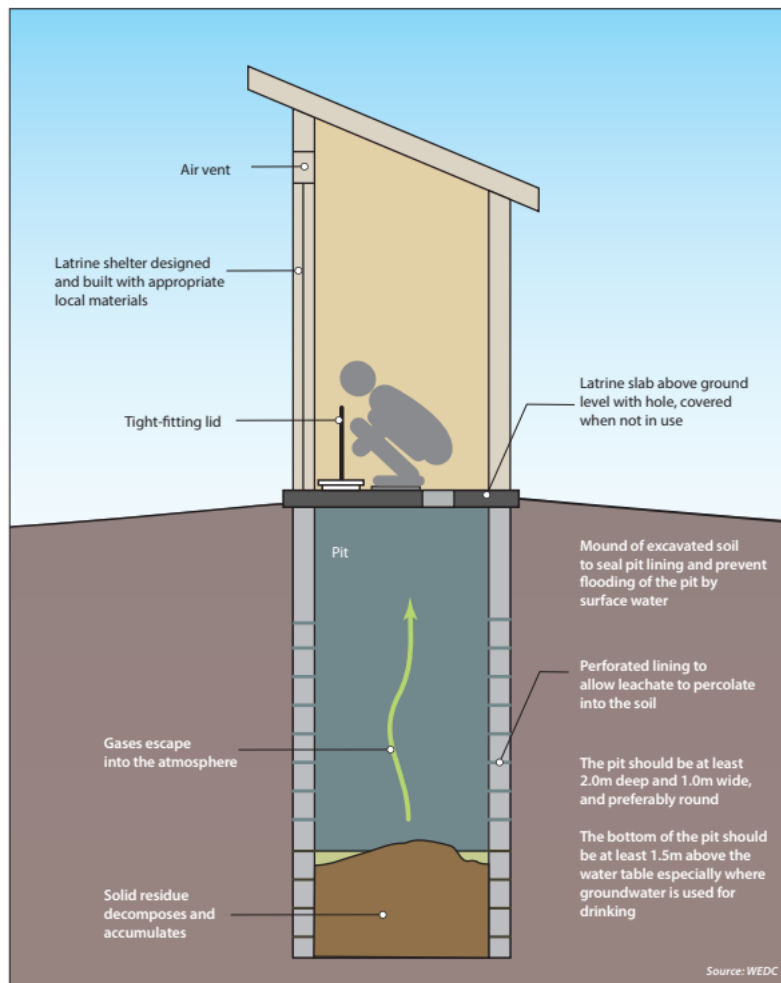

A single pit latrine. (Source: WHO: Guidelines on Sanitation and Health 2018)

## Ventilated Improved Pit

Ventilated Improved Pit (VIP) latrines are an improvement upon the pit latrine. The VIP latrine allows for continuous airflow through the ventilation pipe vents and acts as a trap for flies as they escape towards the light. A well-designed VIP can be completely smell free and provide a significant reduction in flies compared to a traditional pit latrine.

In designing a VIP, it is important that the vent pipe have a diameter of at least 110 mm and extend 300 mm above the apex of the toilet superstructure. This will allow for wind passing over the ventilation tube to create a suction pressure within the vent pipe, thus inducing the air to circulate. Air is down through the User Interface into the pit, and then is pulled through the ventilation pipe and released to the atmosphere. This air circulation will work best in windy areas.

A fly screen should be placed at the top of the ventilation. This will prevent flies from escaping the pit. The mesh size used must be large enough to prevent clogging with dust and allow air to circulate freely. Aluminum screen with hole-sizes of 1.2 to 1.5 mm have been found to be effective.

For more information see: [https://akvopedia.org/wiki/Single\\_Ventilated\\_Improved\\_Pit](https://akvopedia.org/wiki/Single_Ventilated_Improved_Pit) & [https://sswm.info/water-nutrient-cycle/water-use/hardwares/toilet-systems/single-ventilated-improved-pit-\(vip\)](https://sswm.info/water-nutrient-cycle/water-use/hardwares/toilet-systems/single-ventilated-improved-pit-(vip))

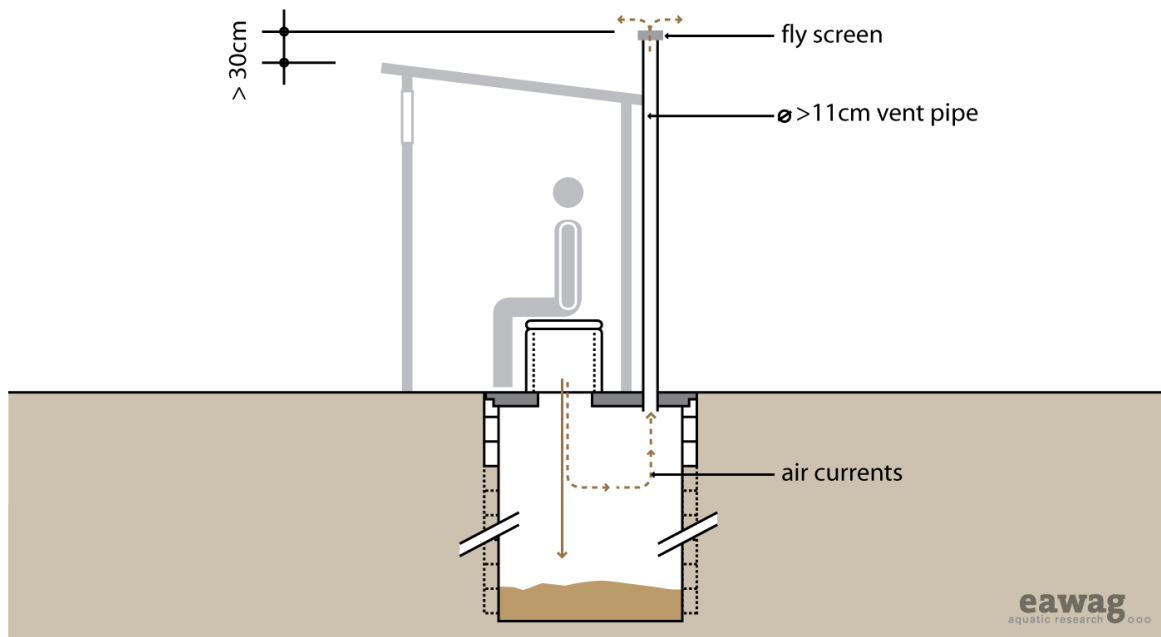

A single ventilated improved pit. (Source: Akvopedia: [https://akvopedia.org/wiki/Single\\_Ventilated\\_Improved\\_Pit](https://akvopedia.org/wiki/Single_Ventilated_Improved_Pit))

### Kumasi Ventilated-Improved Pit

The Kumasi Ventilated-Improved Pit is a modified version of the traditional VIP which is designed with double pits. Utilizing a second pit has the advantage of allowing the system to be used continuously and permits safer and easier emptying. With two pits, one pit can be used while the contents of the second pit rests, drains, reduces in volume, and degrades. The dual pit design typically has a longer lifespan than the single pit VIP; however, there is likely a highly initial capital investment involved constructing two pits. Additional information can be seen at:

[https://www.unicef.org/ghana/Latrine\\_technology\\_option\\_manual\\_final\\_a4\\_size.pdf](https://www.unicef.org/ghana/Latrine_technology_option_manual_final_a4_size.pdf)

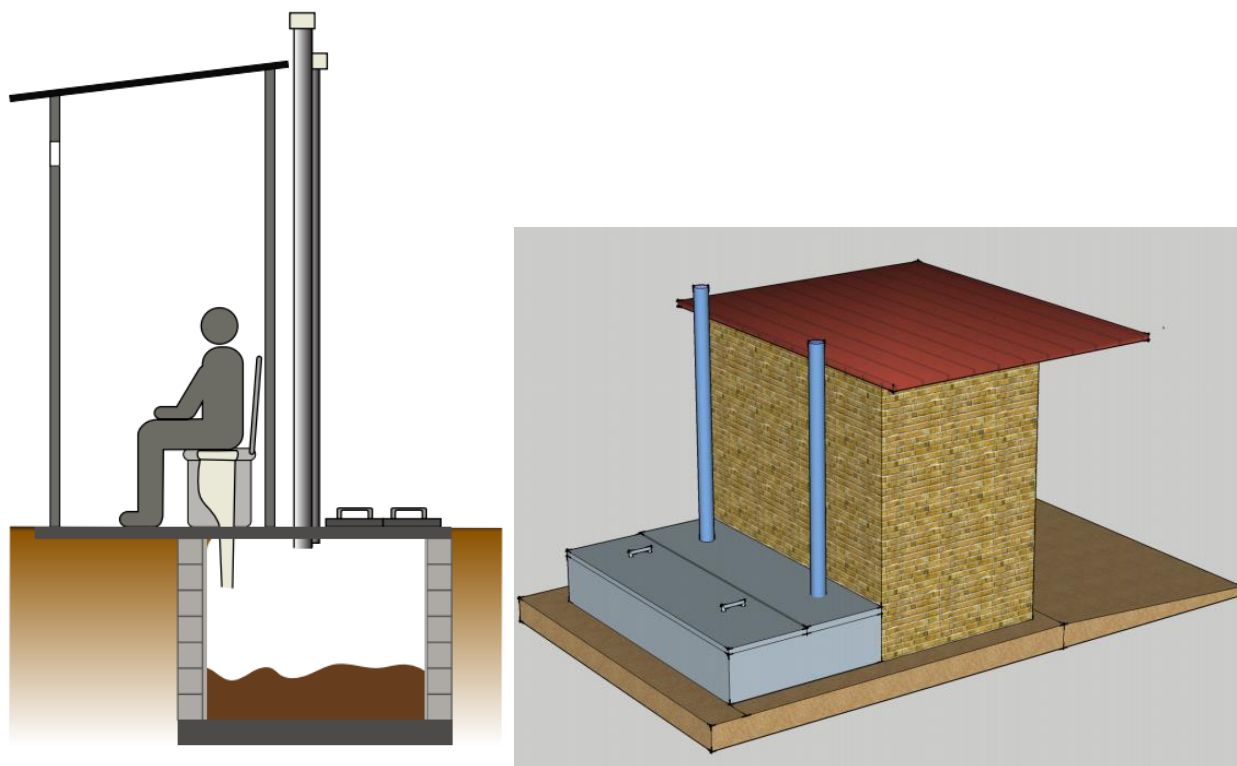

Two-dimensional view of KVIP (left) and back view of KVIP (right) (Source: UNICEF: Latrine Technology Manual)

## Reed Odorless Earth Closet

The Reed Odorless Earth Closet is another variation of the VIP latrine. In the Reed Odorless Earth Closet design, the pit is completely offset from the squatting platform and the excreta falls into the pit through a curved chute. This design allows for the larger pits to be constructed, which allows for a longer design life. The typical design lifetime for this system ranges from ten to twenty years. Additionally, having an offset pit reduces the risk of latrine structure collapsing,

The pits cross-sectional area should not be more than 2 m<sup>2</sup> (21.5 ft<sup>2</sup>) in order to avoid large cover spans. A Reed Odorless Earth Closet serving a single household will commonly have a pit width of 1-1.5 m (3.3-5 ft). Similar to the VIP, the Reed Odorless Earth Closet utilizes a ventilation pipe to circulate air and reduce smell within the latrine. The selected ventilation pipe should extend above the 300m above the apex of the latrine structure to prevent the structure from interfering with air circulation. A fly screen with a mesh size of 1.2 to 1.5 mm should be used at the top of the ventilation pipe in order to prevent the passage of flies. Additional information on the Reed Odorless Earth Closet can be found at: [https://wikivisually.com/wiki/Reed\\_Odourless\\_Earth\\_Closet](https://wikivisually.com/wiki/Reed_Odourless_Earth_Closet)

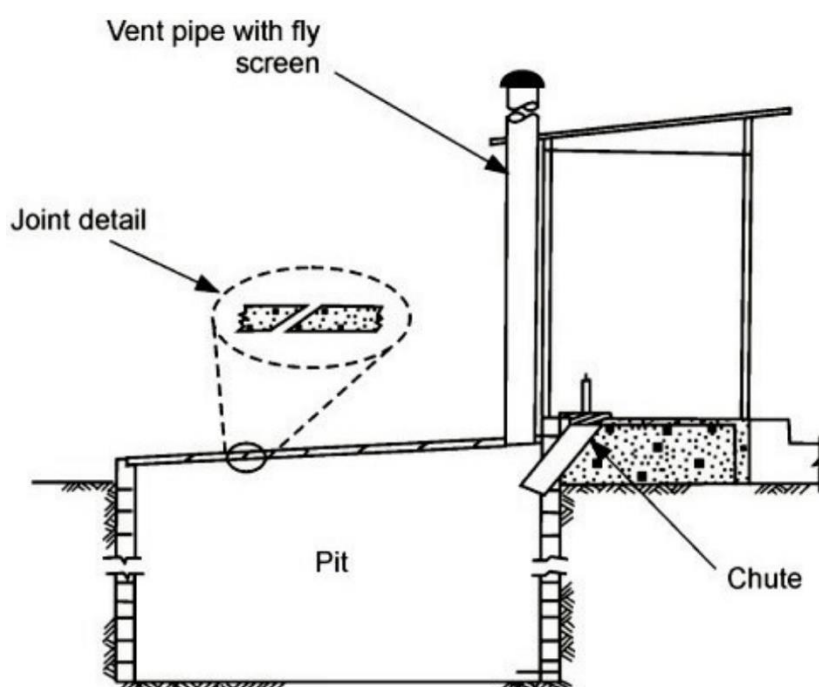

*Reed Odorless Earth Closet design. (Source: Wastewater Recycle, Reuse, and reclamation Vol 2 - Viraraghavan, T.- et al 2007)*

## Composting Toilets

Composting toilets comprise storage/composting vaults which can be constructed above or below ground level to convert excreta and organics into compost—a safe, inoffensive product that can be used as a soil conditioner. Cultural and societal aspects, however, will require consideration, and some technical education will also be required. Composting vaults require moisture control to prevent anaerobic conditions from occurring, and careful balancing of carbon and nitrogen ratios in the waste is necessary for optimal results. Some societies find eating vegetables fertilized by human waste to be objectionable and intolerable and this and other cultural aspects need to be evaluated before any human waste composting installation is undertaken.

In general, toilet compost is hygienically harmless if thermophilic (heat-loving bacteria) composting occurs at temperatures of 55°C (about 130°F) for at least two weeks or at 60°C (140 °F) for one week. However, the World Health Organization recommends composting at 55°C to 60°C for one month with a further maturation period of two to four months in order to ensure satisfactory pathogen reduction.

The optimal process of human waste composting entails regulating the supply of oxygen and moisture (45 to 70% moisture), adjusting the Carbon/Nitrogen ratio (to 25:1) by adding different organic material such as wood chips and/or vegetable scraps, controlling the internal temperature (to 40 to 50°C) and regularly working, or turning, the compost material at least one to two times per year.

However, thermophilic temperatures are not always achieved in most composting toilets. While considerable pathogen reduction can be achieved in a composting toilet, *complete pathogen destruction cannot be guaranteed*. Hygienic measures for handling of compost must be applied by all people who are exposed to it.

Hygienic safety can be improved by secondary co-composting with organic solid waste, and by including other treatment methods such as long-term storage, acidification to raise the pH, exposure to ultraviolet (UV) light.

Composted material from toilets should only be applied to ornamental plants, fruit-growing bushes and trees. It should not be applied directly to food crops such as leafy vegetables and root plants, but it can be used safely as a soil conditioner.

Systems that collect urine in a vault produce larger volumes of leachate. This leachate has to be handled carefully in order to avoid spreading pathogens. The handling, discharge and treatment of excess leachate have to be considered in the planning phase of a composting toilet. Liquid need to discharge to a tank or absorption pit or, alternatively be evaporated through a glass panel or black painted doors concentrating the sun rays onto a flat panel.

A chamber volume of 300 liters (80 gallons) per person per year (which equates to 1.5m<sup>3</sup> (53 cubic feet) per year for a family of five) helps maintain the compost pile temperature between the required 40 and 50° C. A leachate collection system and a ventilation unit that provides oxygen and allows gases to escape are also required. In some designs, a second chamber is provided, allowing one chamber to rest (after filling) while the second chamber is filling. A better alternative is to install suitably sized interchangeable plastic 9 bins to allow for increased storage and degradation time. Storage vaults may be located under the house, but they must be sealed to reduce water access when installed in flood-prone areas.



*Eco Toilet with Solar heated processing Chamber and Moveable Basket Feces Containers*

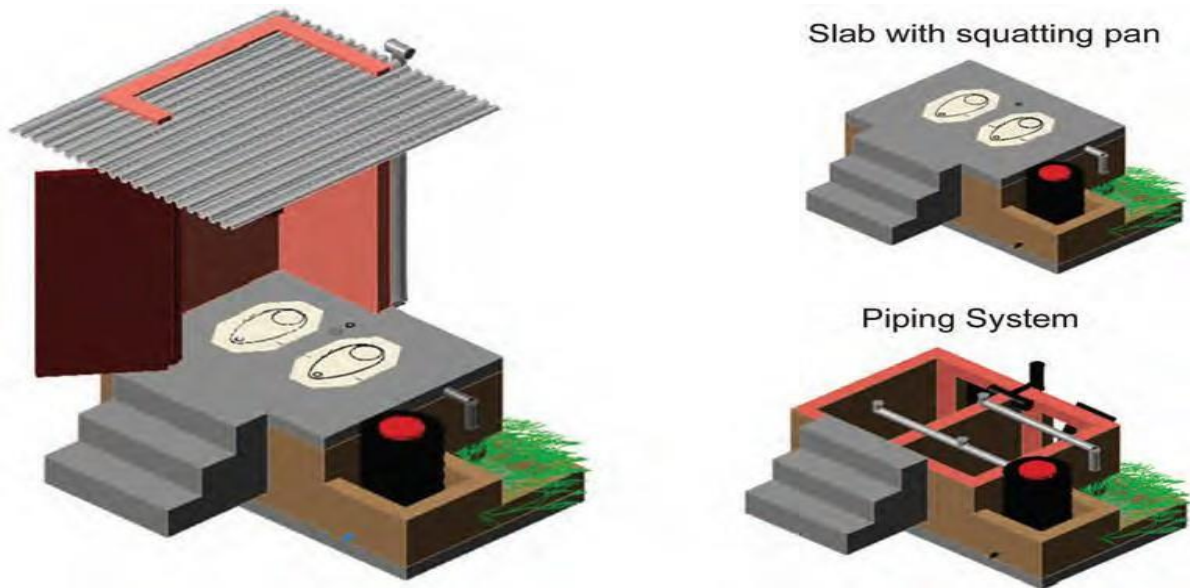

*COMPOSTING TOILETS - Single above with transportable bins and double chamber below where a full chamber is composting while the second chamber is filling with use. (See WaterAid in Nepal (2011) Technical Handbook - Construction of ecological sanitation latrine- Source EcoSan GTZ)*

Due to their compactness and operation composting toilets are especially suited to warmer climates and areas where land and water are limited. They can be used indoors to ensure that low temperatures do not impede the composting process. In colder areas solar panels help elevate the temperature. Anal cleansing water should not be added to the composting chamber as anaerobic conditions could occur along with foul smells and reduced collection capacity. For more information see: <http://www.sswm.info/category/implementation-tools/water-use/hardware/toilet-systems/composting-toilets>

### Urine Diversion Dehydration Toilets

Urine Diversion Dehydration Toilets (UDDT) are ideally suited to flood-prone areas provided its working platform is placed above flood level and the doors to the dehydration vaults are sealed when flooding occurs. Also known as EcoSan Toilets, they operate without water, which allows the urine to be collected **separately** from the feces. Urine and dry feces can then be applied to as a crop fertilizer and soil enhancer. Urine empties into a separate plastic container beneath the floor. Feces, which are deposited through the large apertures of the pans in the photo below into a closed chamber or plastic bin with lid or even locally available palm leaf baskets. Each deposit is covered with a small amount of ashes, straw/dry grass or earth, which absorbs the moisture, reduces smells and assists in the dehydration process.



*LEFT: Fiber Reinforced Plastic urine-diversion squatting pan with anal cleaning water collection bowl (Source: WAFLER (2010). RIGHT: Ceramic urine-diversion pedestal with separate bowl for collection of anal cleansing (Source: UNESCO-IHE).*

A two-chamber unit allows a full chamber to be closed down to allow the dehydration to take place (killing pathogens) while a second chamber is filling. This action takes place over a period of 6 to 9 months in hot climates or up to 2 years in colder climates, producing a friable dry material which can be safely handled a soil conditioner. Where a third dedicated hole for anal cleansing water (ACW) is provided, it is most important for the ACW and the urine to be kept separate from the feces for it to remain dry while dehydration takes place.

For guidance on Double Chamber EcoSan toilets see:

[https://sswm.info/sites/default/files/reference\\_attachments/WATER%20AID%202011%20Construction%20of%20Ecological%20Sanitation%20Latrine.pdf](https://sswm.info/sites/default/files/reference_attachments/WATER%20AID%202011%20Construction%20of%20Ecological%20Sanitation%20Latrine.pdf)



*Sulabh Twin EcoSan Toilet (India) showing urine bowl (front), feces opening (center) and anal washing bowl at rear. Note separate lid to cover feces opening when second chamber is dehydrating. A second cover should also be placed over the feces opening of the chamber in use to avoid water wetting the feces during anal cleansing.*

The UDDT is not immediately obvious in its function, which to some degree is its disadvantage, making demonstration and education of use and maintenance an ongoing necessity before and during its early use. UDDTs are becoming more accepted due to their suitability of use in flood prone lands and their ability to return both urine and dehydrated feces to the soil. Due to their more permanent life capability, the above ground enclosed structure tends to be constructed of more durable materials, such as brick and/or corrugated metal, which increases their cost. They are extensively used in school toilets both in the two-vault-s and single-chamber version. These larger units need to have 40- to 60-litre (10 to 16 gallon) plastic drums which can be transported to a secondary secured area for storage while dehydration takes place.



Double Chamber brick UDDT Toilet Base

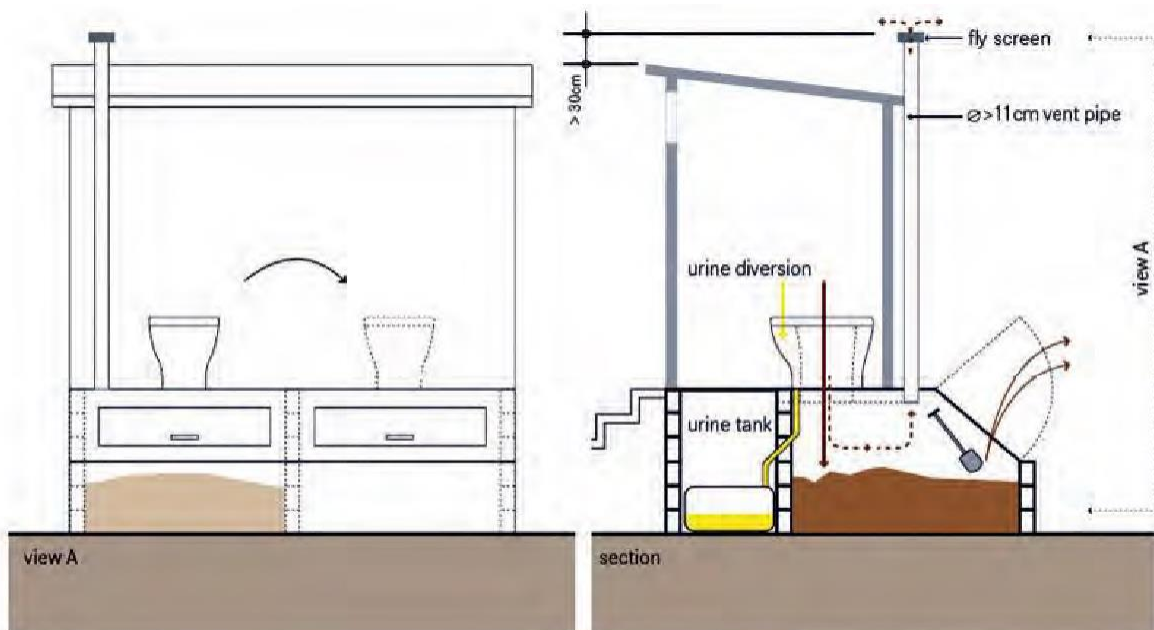

*Double Chamber UDDT with Solar Access Doors to Feces Chamber (See: WaterAid in Nepal (2011) - Technical Handbook - Construction of ecological sanitation latrine. Source: et al Tilley 2008)*

A single chamber unit for households is usually about 150 to 200cm long, 90cm wide and 80 to 90cm high (about 60-80"X35"X35"). Any second chamber is constructed to identical dimensions beside the first chamber. Chamber wall construction is usually of brick or concrete block although bamboo, timber or light steel frame can be substituted as an alternative with a timber floor and either an EcoSan squat pan (shown above) or a drop through pedestal pan. These units are generally

fitted with a 40L (10 gal.) or larger plastic or rattan basket containers, which must be closed over after filling for storage and dehydration. It is desirable to keep the moisture content of the feces to around 25% while maintaining temperatures up around 50°C (125 °F) or more to create a dry environment for pathogen destruction, which can be further aided by adding ashes, dry sand or straw etc. Maintaining temperatures of 43°C or more for one month will see most pathogens killed off, although 6 months is usually adopted as the minimum retention time in the warmer climates. In cooler climates, dehydration can be assisted by fitting the chamber with black painted sloping access doors. The system is most suitable for dry and/or hot climates such as Southeast Asia, India and Africa.

The brick and /or concrete walls of the vault should be constructed on a 75mm to 100mm (3 -4") thick reinforced concrete slab at ground level to provide an impervious chamber. An access hatch is provided either to the rear or side wall to allow the feces to be worked every few weeks (see diagram and note above). The hatch must be fitted with a sealable door where the toilet is constructed in a flood prone area to avoid the dehydrating material becoming wet again. Painting the access door black helps maintain higher chamber temperatures which assist dehydration. A small video fully describing the principles can be seen at: <http://www.youtube.com/watch?v=YV-1To9DkIQ>.

Costs of single locally constructed UDDTs are slightly more than a pit latrine. Facilities using removable containers require a separate secure drying area to be established to facilitate secondary treatment of the material prior to final placement in the soil. See reference 1.0 on page 19 for single chamber wood fabricated chamber.



*Inclined metal chamber doors inclined towards the sun to increase heat in the chambers  
(Source: Sswm and Crepa 2007)*

Provision of both female and male urinals particularly in schools facilitates the operation of the UDDT and has been found to assist in the maintenance of cleaner facilities. Having school children provide ashes from home (cooking) fires ensures an ongoing supply for covering deposited feces. For further information including details on advantages and disadvantages of the UDDT and related topics see; <http://www.sswm.info/category/implementation-tools/water-use/hardware/toilet-systems/uddt>.

A project undertaken in Nyanza and adjacent provinces in Kenya between 2006 and 2010 saw the construction of 263 UDDT's in 70 schools and more than 600 in households. The Objectives and



motivation of the project were:

- To improve the learning conditions of the students through improved sanitation facilities and accompanied hygiene education. The sanitation solutions had a focus on the reuse of human excreta as a resource. This concept is also known as ecological sanitation (EcoSan).
- To engage a wider audience of schools and the surrounding households, so called clusters in order to support, stimulate and create demand for EcoSan in the area.
- To engage the children as effective agents of change. Children pass on their knowledge of better hygiene practices and improved facilities from school to their parents and thus influence the communities.
- The toilets built under this program mainly served as an entry point for promotion and awareness raising only. The number built per school (usually four cubicles) was too few to have a real impact on the everyday life of the pupils. A complete report can be viewed at: <http://www.susana.org/resources/documents/default/2-1195-en-susana-cs-kenya-schools-uddts-24nov2011.pdf>



*UDDT School Toilet at Nyanza, Kenya with UDDT on the left, urinal in right compartment, rainwater collector/hand washing tank.*

### **Amila 3 Biofilter Toilet System**

The Amila 3 Biofilter toilet system was designed to provide a low-cost household solution to overcome soil pollution restrictions after the Sri Lankan tsunami. It uses 44-gallon petrol drums as a septic tank with settled liquid drained off the top into the base of a second drum filled with sand from which the secondary effluent rises to safely discharge through slotted pipes (leach lines) into surrounding soil. Walls of both tanks can be constructed from locally available materials such as mortared brickwork, concrete or metal. The Biofilter material can be sand or graded stone, which reduces the oxygen demand of organic materials passing to the drainage field by emitting a cleaner effluent to the soil. The system is seen as being sustainable provided both tanks are cleaned and maintained on a reasonably regular basis.

Its advantages lie in its simplicity, low construction costs and ability to be built from locally obtainable materials and by local inhabitants. Its main disadvantage is that the shallow field absorption lines must be kept clear of water sources and sandy soils to avoid pollution. These lines are 75mm to 100mm (3 to 4 inches) diameter slotted plastic or ceramic pipe covered with geotextile fabric and one-size rock to prevent clogging of the slots; the pipes are laid on 15cm of one-size rock

in 40cm wide by 50cm deep trenches. Depending upon the soils, two to three rows of 20-metre-long pipe set about 5 meters apart should work for 10 to 15 years. At the end of this period a new leach field should be constructed perpendicular to existing field and the old field retired.

(Reference: Sanitation Now 2008 publication of The Stockholm Institute- Amila 3 awarded second prize in the 2006 Kyoto World Water Grand Prize competition)

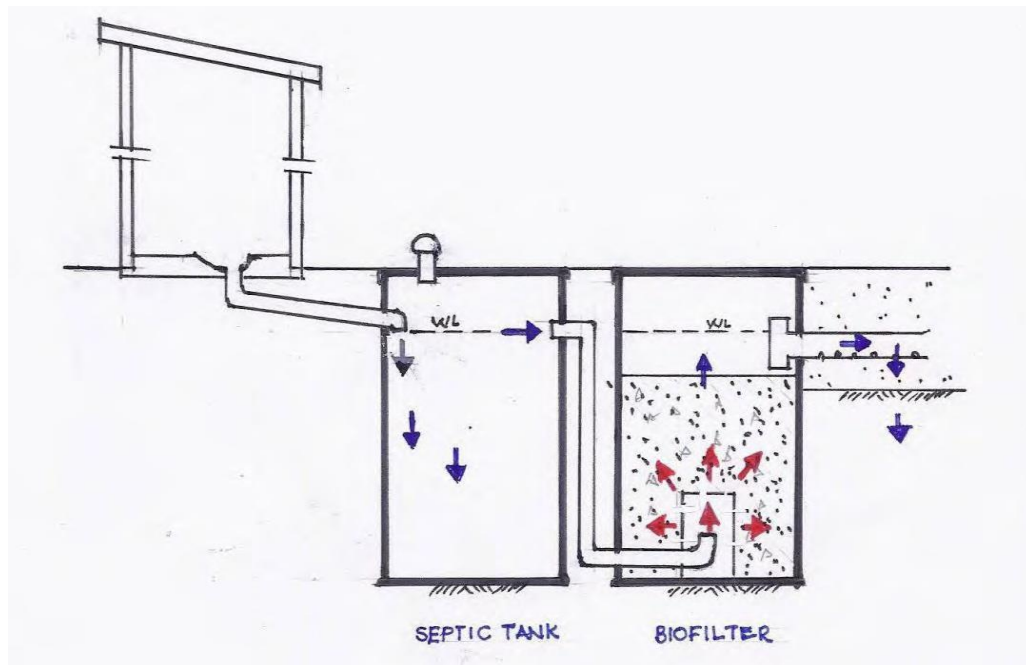

## Anaerobic Bio-digester Reactor

An Anaerobic Biogas Reactor produces digested slurry that can be used as a soil additive and a biogas which can be used for cooking, heating and powering small plants to produce electricity. Biogas contains a mixture of methane, carbon dioxide and other minor gases. Biogas digesters can be used by a single household, a neighborhood city area, and school toilets. The reactor comprises a large cylindrical chamber which aids the anaerobic breakdown of blackwater, sludge and other biodegradable wastes, including animal wastes, food wastes and certain plants. The tanks can be built above or below ground and can have prefabricated components (such as a roof) or on-site construction using local labor and bricks or concrete. Some research is being undertaken using plastic tanks and heavy HDP polyethylene sheets for the gas chamber dome roof, which can be fixed or floating. At the household level, reactors with a volume of about 1,000L (about 260 gallons) can be built from plastic containers or bricks at or below ground level. Size increases to about 100,000L (about 26,000 gallons) for institutional or public toilet applications.

The input material of human, animal (pig and cow manure) and organic waste is retained for a minimum of 15 to 25 days depending whether the reactor is located in a hot or temperate climate. During the fermentation process, gas is generated which exerts a pressure, displacing the slurry upwards into an expansion chamber. When the gas is removed, the slurry flows back down into the expansion chamber. The generated pressure is then used to transport the biogas through pipes. These units are similar to a septic tank in the waste it produces but with the addition of the beneficial biogas.

The majority of biogas reactors are directly connected to private or public toilets with an additional entry point for organic materials. Although odorless and rich in organics and nutrients the slurry will need further (thermophilic) treatment to complete pathogen destruction.

Advantages:

- Generates a usable energy source;

- Low capital and operating costs as no electrical energy is required;
- Underground construction minimizes land requirement and long life span.

Disadvantages:

- Requires expert design and skilled construction personnel;
- Depending on size, digested sludge requires regular removal and effluent still requires treatment.

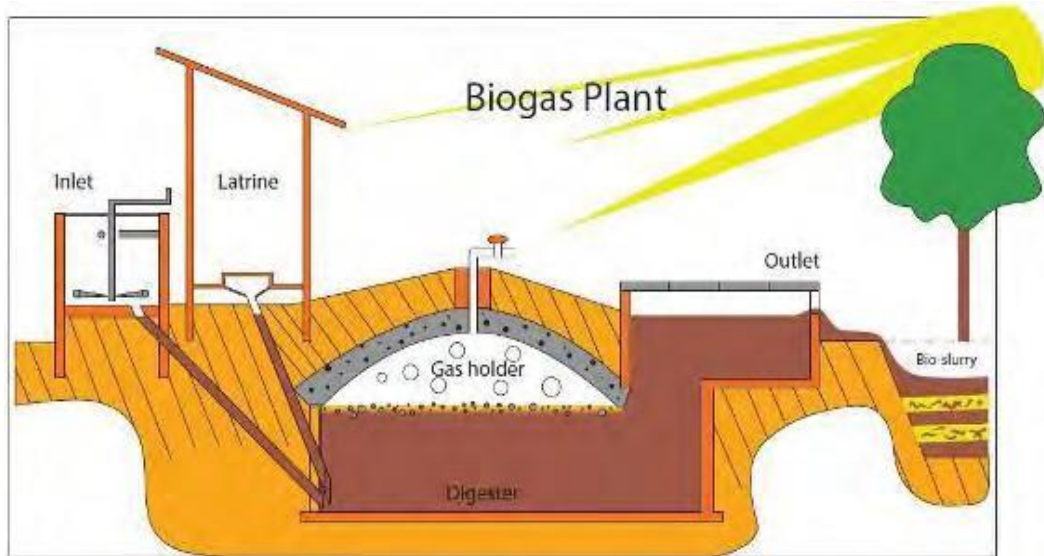

For examples of this product refer to: <https://www.susana.org/resources/documents/default/2-131-en-susana-cs-kenya-naivasha-biogas-public-toilet-final-2009.pdf>; <https://sswm.info/category/glossary/anaerobic-digestion> is and other technologies can be found in [www.akvo.org](http://www.akvo.org) /sanitation portal reference: Tilley E. et al (2008) "Compendium of Sanitation Systems & Technologies."



Checking the gas valve of a floating-dome [biogas reactor](#) in India (left) and lighting the biogas flame (right, Lesotho, 2006). Source: BIOTECH India (2007) and MUENCH (2008).



*Biogas Digester under construction by Umunde Trust, in Nairobi. A Bio center is constructed over the digester with public toilets on the ground floor and a kitchen, office and meeting room on the first floor. Power and cooking fuel are derived directly from the gases generated from the urine and feces derived from use of the public toilets and stored in the dome.*

## Anaerobic Baffled Reactor

**This technology is suitable for installation in tightly packed residential areas, like slums.** The reactor is an enlarged septic tank fitted with a series of baffles through and under which wastewater is forced to flow before discharging to either a perforated pipe leach field (see Urine Application) or a small-bore pipe which can discharge to a sewer. The increased contact time with the active sludge in the reactor improves overall treatment. This technology can be applied to large households with high water usage for showers, washing clothes and toilet flushing, or in small neighborhoods as well as at small community levels. It should not be used in ground with high water tables nor should it be used where immediate treatment is required because it takes several months to commence operation. It is more suited to warmer climates. The sludge requires annual removal or further treatment, such as connecting it to a biogas reactor which in turn produces gas for cooking lighting and heating. It has a long service life but needs to be installed by specialist personnel and maintained by trained personnel. For further information see: [https://akvopedia.org/wiki/Anaerobic\\_Baffled\\_Reactor \(ABR\) 1](https://akvopedia.org/wiki/Anaerobic_Baffled_Reactor_(ABR)_1).

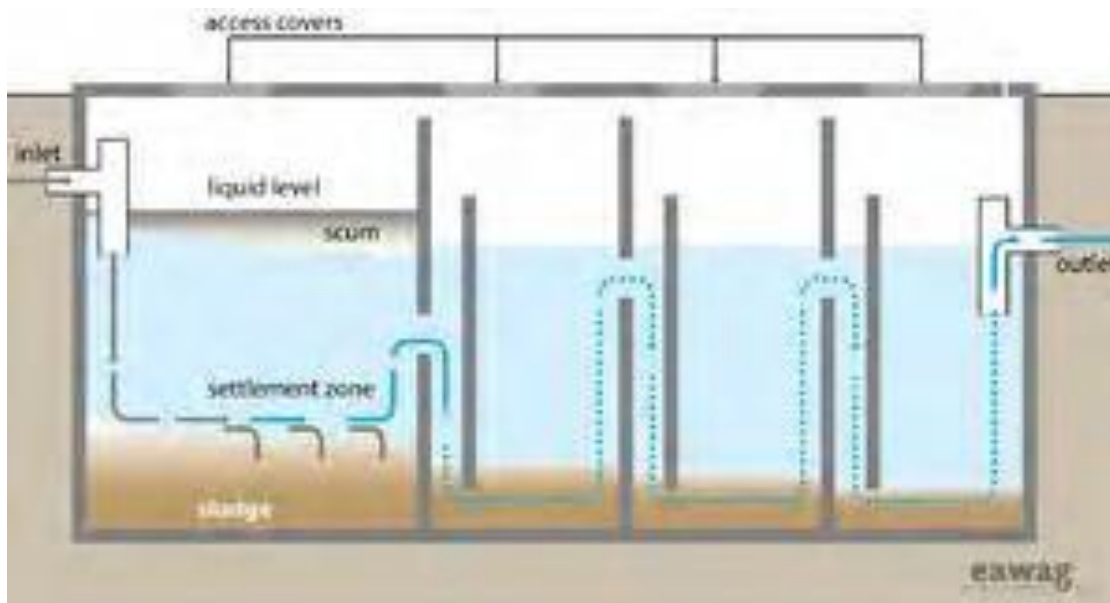

(Drawing courtesy of Sandec Ewag)

## Fossa Alterna

Fossa Alterna is an alternating waterless, dry double-pit ventilated sanitation technology. It is designed to make compost which can be used as a soil amendment. The pits are partially lined and are no more than 1.5 meters (5 feet) deep. They require a constant input of soil, ashes and/or straw, which is required for degradation and a dry material.

They initially are more expensive to build than a VIP latrine as two pits are required about one meter (40 inches) in diameter over which a cover has to be constructed. They can be used again repeatedly. One pit is used at a time. When full (which is dependent upon the number of users—12 to 18 months), the superstructure, which should be of light weight construction, is moved over the second hole and the first is temporarily sealed. During this time, the full pit goes through a degradation process and is transformed into a dry mixture similar to compost that can be easily removed after about 12 months. As with similar technologies, soil, ash and leaves must be added to the pit after each defecation and urination. This addition makes the material more friable and the ashes add to an increase in pH which assists in the breakdown of pathogens.

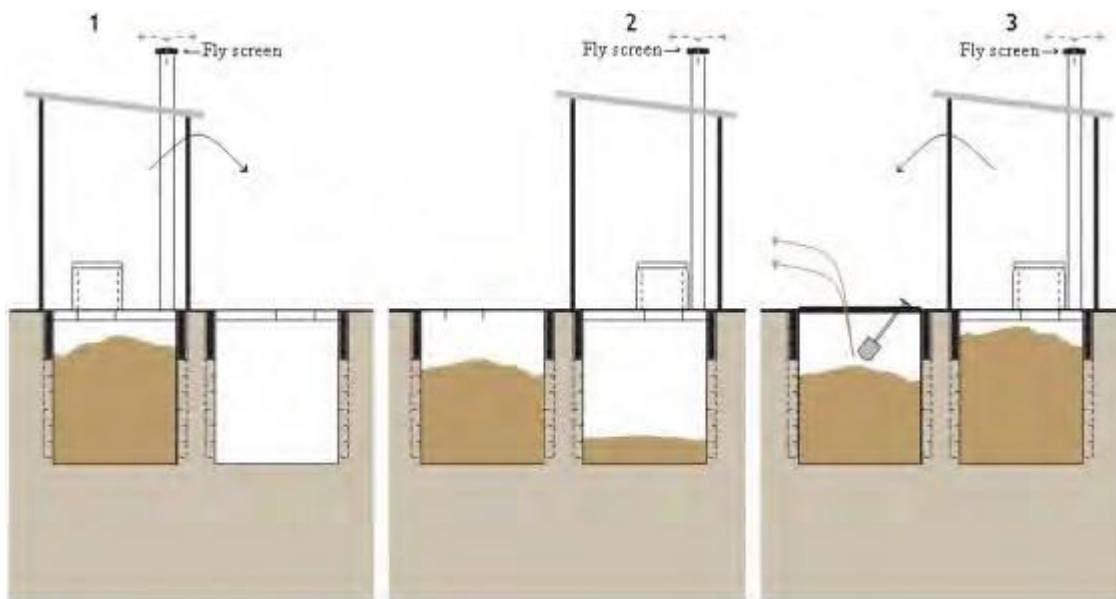

*Functional staging of pits and superstructure. Source; SSWM – Stauffer/ Tilley et al - 2008).*

The system can operate successfully with or without urine, but water must not be added as this leads to vectors and pathogens. Water also fills the pore space and deprives the aerobic bacteria of oxygen, which is required for degradation.

The main disadvantage of the fossa alterna system is that it cannot be installed in areas containing rock or hard clays or where the water table is high, or where flooding occurs. It requires correct use of the compost material and a constant supply of soil, ash and leaves. Because it is shallow and the waste is of a lighter humic nature, the pit is easier to clean out compared to fecal sludge from pit latrines.

Fossa alterna systems are relatively cheap to construct and can be easily built on site using local labor and materials where available. For more details see:

<http://www.sswm.info/category/implementation-tools/water-use/hardware/toilet-systems/fossa-alterna> and; <https://www.susana.org/en/knowledge-hub/resources-and-publications/case-studies/details/88>.



*Fossa Alterna toilets – Source: SSWM-SuSanA on Flickr (2010).*

## Arborloo

An Arborloo toilet is a single shallow temporary VIP latrine that has a maximum depth of about 1.5 meters (5 feet) over which a toilet consisting of a ring beam, slab and structure is placed. When the latrine is filled to within about 40 centimeters (16 inches) below the ground surface, it is then finally covered with soil and a (fruit) tree is planted. Soil, ashes and leaves thrown over each urination and defecation provides a rich material that will compost over a period of time. Nitrates from decomposing feces provide rich soils for trees. The ring slab and toilet structure are transferred to a second pit clear of the first when it is full. The operation is endless provided there is sufficient land available. A large crop of trees can result over a period of years. The system is **not suitable** for areas subject to flooding or where there is a high water table and sandy soils as ground water contamination can occur. Provided the owner is capable, the technology will cost very little to build and install because unskilled local labor and inexpensive materials can be used for construction. For further details see:

<http://www.sswm.info/category/implementation-tools/water-use/hardware/toilet-systems/arborloo>.

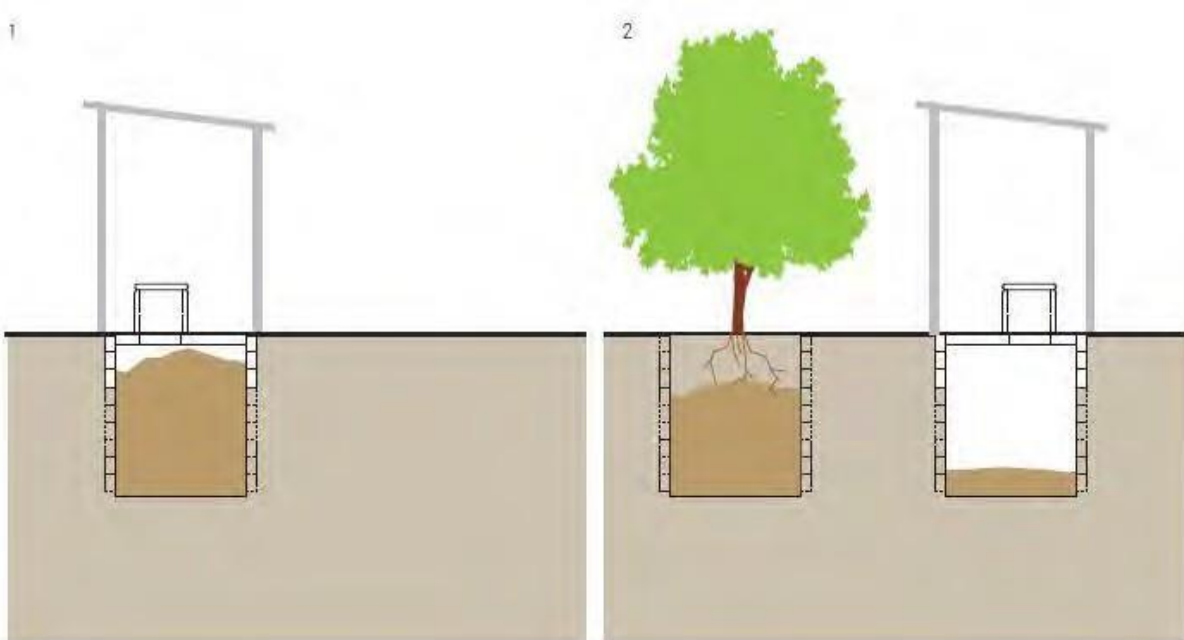

*Feces are deposited in the pit of an arborloo until it is near full. Then a second pit is dug, the latrine structure is moved over the new pit. A tree (preferably a fruit or nut tree) is planted in the first pit. (Source: SSWM- Tilley- et al 2008))*

For details of the installation of a number of household Arborloos undertaken at Arba Minch in Ethiopia see: <https://www.susana.org/en/knowledge-hub/resources-and-publications/case-studies/details/86>.

## Twin Pits for Pour Flush

A pour flush toilet is similar to a normal flushing toilet except that the 1 to 3 liters of water is poured into the cistern by hand instead of having the water delivered from a cistern after pressing a button. The toilet bowl is shallower and fitted with a water seal at the neck which prevents any odors or flies from coming back up the discharge pipe into the toilet chamber. Toilet paper should not be flushed down the bowl as the water may not have sufficient force to move the paper over the neck.

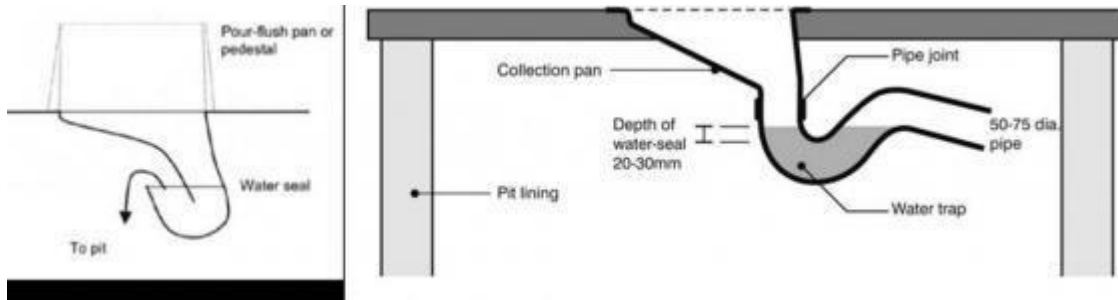

A pour flush toilet can discharge directly into a single pit either under or adjacent to the toilet structure. It can alternatively discharge into twin pits which then allow both black and grey water to be collected and allowed to slowly infiltrate into the surrounding soil. Over time the solids are sufficiently dewatered to the extent they can be removed by shovel. The structure can be either moved around or left in the same place relative to the pits. Only one pit is allowed to be used at a time while the other is slowly allowing liquid waste to drain off through slots built into the walls (generally of brick construction) leaving safe inoffensive soil-like material. While similar to the fossa Alterna, the twin pits do not require the addition of soil and organic material because they contain water.

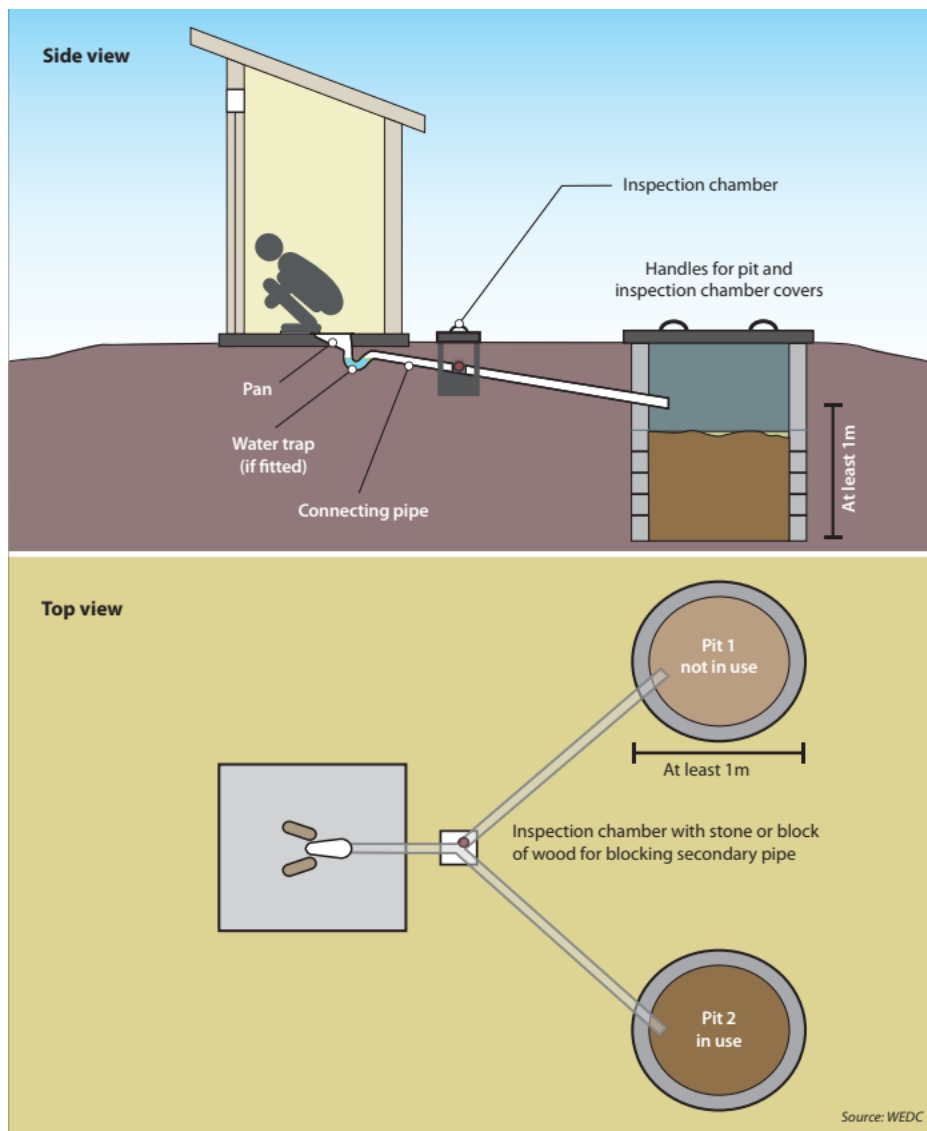

A twin-pit pour flush latrine. (Source: WHO: Guidelines on Sanitation and Health 2018)



Pits are usually about one meter in diameter, are placed about one meter clear of each other and must be located at least 30 meters (100 feet) clear of, and downhill of, any water source to reduce ground water pollution. At least one year should be allowed for retention prior to the pit being excavated. Some conditions may require a retention time of an additional year.

The system is suitable in areas where there is insufficient room to continuously move pit latrines but unsuitable for areas with high ground water table and unreliable water supply or areas where frequent flooding may occur and in sandy type soils close to water resources. It must be carefully sighted to reduce pollution of soils which should be very absorbent; they should not be placed in tightly packed clays or rocky soils. See also: <http://www.sswm.info/category/implementation-tools/water-use/hardware/toilet-systems/pour-flush-toilet> (Also Source of Diagrams)

## Micro-Flush Toilet

The micro-flush toilet is a sanitation system that is able to flush with just a small quantity of water, with amounts around 150 cc of water having been shown to be effective. The design utilizes a small flap which holds the water. After defecations, the user pulls a level to allow the flap to pivot and dispose of the excrete into the pit system. The water present on the flap is then replaced. Typically, this design will be used in conjunction with a handwashing station, where the grey water from the hand washing station is diverted and used for flushing the toilet.

The micro-flush system can be incorporated into multiple designs, including the usage of a macro-organism enhanced aerobic digester, as discussed in the additional documents. Utilizing the micro-flush design can provide a safe and reliable system that efficiently utilizes available water resources. More information is available at: <https://globalsustainableaid.org/gsap/gsap-microflush-toilets/> & <https://www.witpress.com/Secure/elibrary/papers/ECO13/ECO13010FU1.pdf> & <https://peerj.com/articles/6077.pdf>

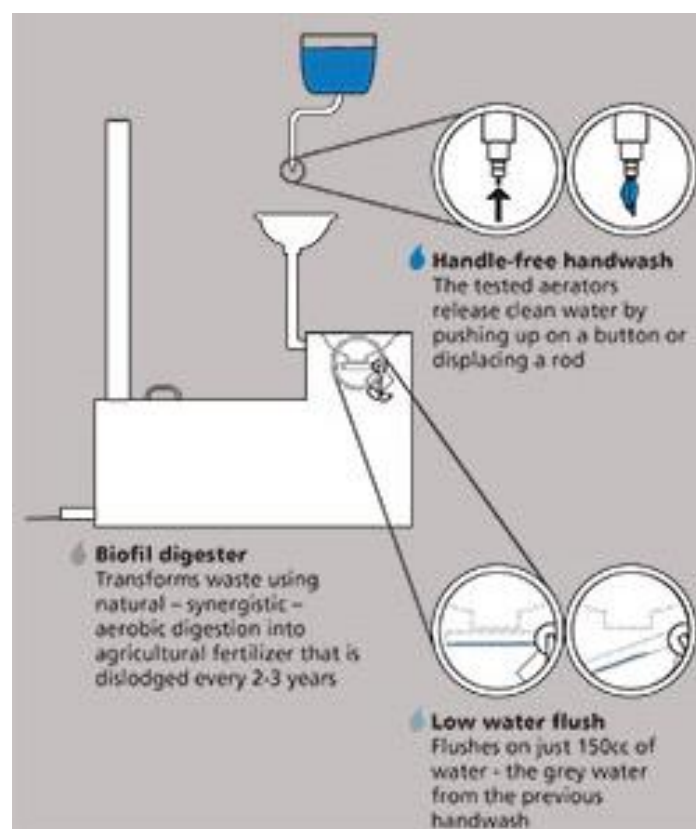

Micro-flush toilet design. (Source: Application of GSAP Microflush Toilets: a sustainable development approach to rural and peri-urban sanitation - Mecca, S.- et al 2013))

## Decentralized Wastewater Treatment Systems

A Decentralized Wastewater Treatment (DEWAT) system is a proprietary technical approach to providing a solution to physical and biological wastewater treatment. It comprises a separation settling tank, an anaerobic baffled reactor, an anaerobic filter, and a planted gravel filter. It uses local materials in its construction. The system is suitable for hospitals and agricultural industries. It provides communities with an environmental sanitation solution with other benefits, such as biogas generation if installed to supply gas for cooking, lighting and heating.

The selection of this technology is similar to the anaerobic reactor and would need professional engineering/sanitary engineering, community and government input because of its size. See also:

- <http://www.youtube.com/watch?v=n9EzBNuR0cM&NR=1&feature=endscreen;>
- <https://www.borda.org/solutions/decentralised-sanitation-systems-2/#dewats>
- <https://sswm.info/content/decentralised-wastewater-treatment-system>

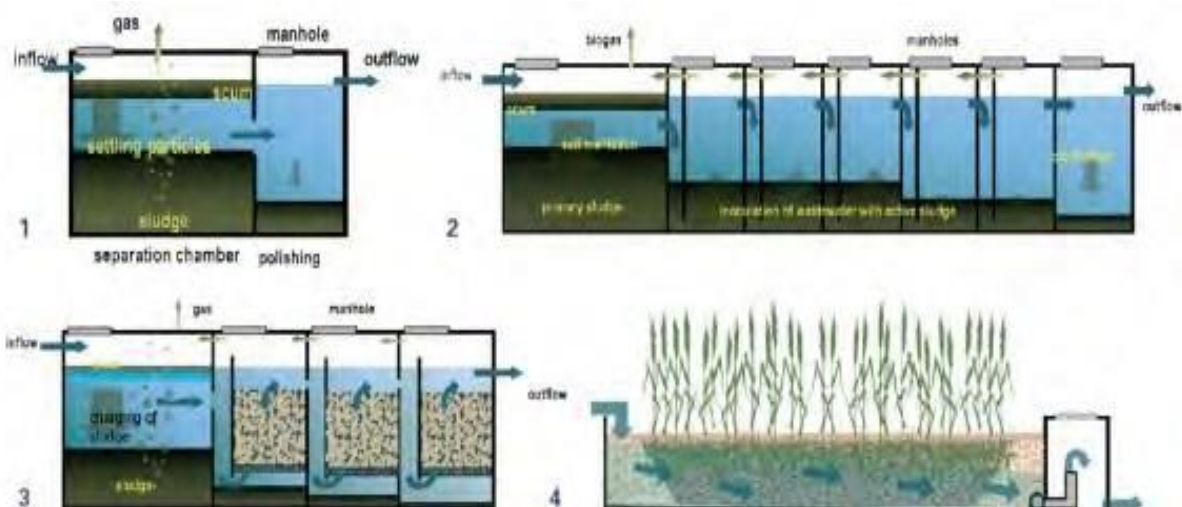

## Septic Tanks, Leach fields and Wetlands

This facility is a water tight chamber now made of concrete, fiberglass or various kinds of plastic for the initial treatment of both black and grey water. Solid waste settles to the bottom while the liquid stays on the top and a moderate anaerobic process reduce solids and organics. The tank is a two chamber layout with the first main chamber occupying two thirds of the total length in which most of the solids settle. A baffle between the two chambers allows the effluent to access the second chamber but its location is such as to prevent scum and solids from escaping with the effluent. Sizes vary according to household numbers and amount of waste.

The rate of accumulation is generally faster than the rate of decomposition which results in having the settled waste removed by mechanical vacuum vehicle every 3-5 years. The effluent escapes via a T shaped outlet pipe to a four line leach field or a horizontal Subsurface Flow Constructed Wetlands.

Septic Tanks are most suitable for single households but require a minimum area of around one hectare of land if using leach fields as there is a need to relocate the leach field after about 15 years but less if using transpiration beds or wetlands. Leach fields comprise slotted plastic pipes laid in trenches up to about one meter in depth depending upon the soils and filled with clean crushed rock size, with heavier soils requiring much larger field than sands and the like. They must not be placed close to water sources of any kind or in close proximity to the sea.

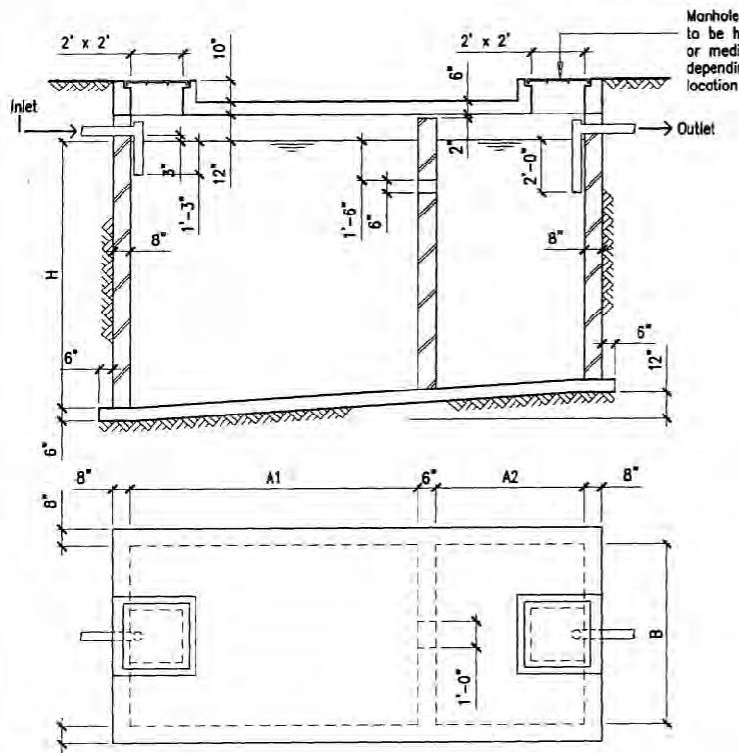

Manhole cover to be heavy duty or medium duty depending on location

**Note:**

Septic tanks are to be constructed in accordance with the designs which have been approved by the Ministry of Health. The drawing here provided is for a typical single family dwelling and may not be the same as that provided by the Ministry.

**Walls:**

6" reinforced concrete with 1/2" dia. bars at 8" vertically and 1/2" dia. bars at 16" horizontally, or:

8" concrete blocks filled with 1:3:6 concrete and with ladder type reinforcement every other course. The inside face to be plastered with two courses of 3/8" thick cement mortar.

**Top and Bottom Slabs:**

6" reinforced concrete with 1/2" dia. bars at 9" centres transversely and 3/8" dia. bars at 12" centres longitudinally.

Slope of bottom slab to be 1/4" to 1'-0".

Access hatches to be patented cast iron or steel covers 18" square, or of 4" thick concrete with 4" mesh reinforcement.

**Dimensions:**

H = 3'6"; A1 = 5'0"; A2 = 2'6"; B (width) = 4'6".

## SEPTIC TANK CONSTRUCTION

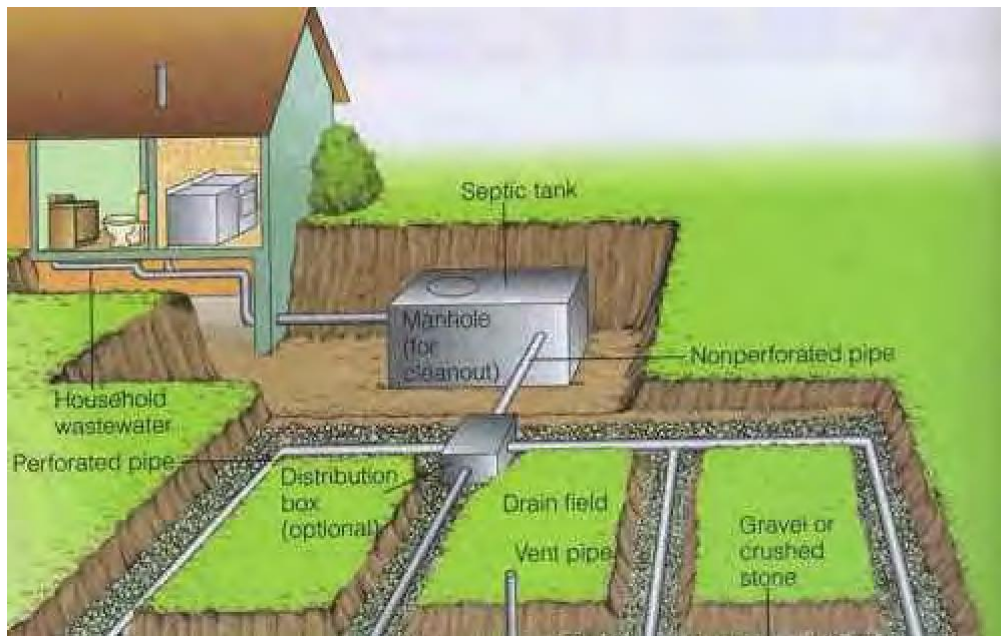

## LEACH FIELD CONSTRUCTION

In smaller tracts of land, a Horizontal Subsurface Flow Constructed may be a better solution. This treatment can be used in single households, neighborhoods and cities including public toilets but is dependent upon availability of adequate land. Unlike the leach field it has the ability to dramatically reduce the biological oxygen demand (BOD), suspended solids and pathogens of the effluent. It can be constructed with local labor, but requires expert design and construction supervision. Current plants include duckweed, phragmites australis (water reed), and a new plant, vetiver.

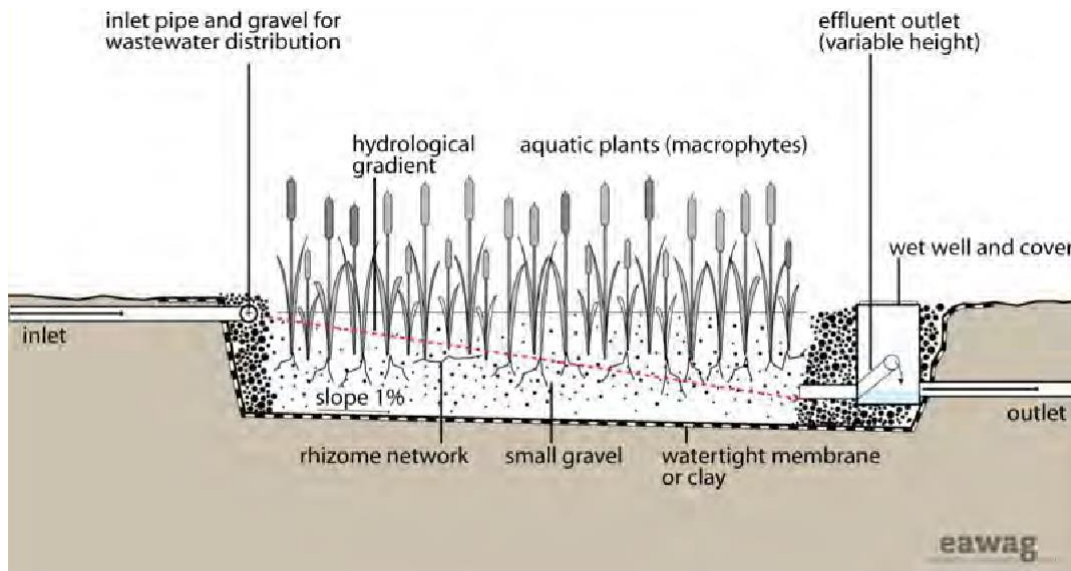

### HORIZONTAL FLOW CONSTRUCTED WETLAND



For further Information see:

- <http://www.sswm.info/category/implementation-tools/wastewater-treatment/hardware/semi-centralised-wastewater-treatments/s>
- <http://www.sswm.info/category/implementation-tools/reuse-and-recharge/hardware/recharge-and-disposal/leach-fields>
- <http://www.sswm.info/category/implementation-tools/wastewater-treatment/hardware/semi-centralised-wastewater-treatments/h>
- [http://en.wikipedia.org/wiki/Vetiver\\_System](http://en.wikipedia.org/wiki/Vetiver_System)

# Waste Handling and Application

## Urine Application

Working with urine is generally safe and requires little consideration other than keeping containers sealed and stored for about a month when obtained from a household, but according to the WHO up to 6 months where urine is used for crops of food eaten by those other than the urine producer. It should be applied in a diluted form of about 5:1 via furrows between rows of plants, in holes near plants, or through drip lines and **not directly** over or sprayed on vegetables, flowers or trees. It should not be applied to crops in the month prior to harvesting. As seen from the following tables, urine can have some pathogens but (Tilley et al 2008) it is unusual for these to be in such numbers as to be of concern to the health of handlers.

### POTENTIAL PATHOGENS IN URINE

Healthy urine on its way out of the human body may contain up to 1,000 bacteria, of several types, per milliliter. More than 100,000 bacteria of a single type per milliliter signals a urinary tract infection. Infected individuals will pass pathogens in the urine that may include:

<u>Bacteria</u>	<u>Disease</u>
<i>Salmonella typhi</i>	Typhoid
<i>Salmonella paratyphi</i>	Paratyphoid fever
<i>Leptospira</i>	Leptospirosis
<i>Yersinia</i>	Yersiniosis
<i>Escherichia coli</i>	Diarrhea
<u>Worms</u>	<u>Disease</u>
<i>Schistosoma haematobium</i>	schistosomiasis

Source: Feachem et al., 1980; and Franceys, et al. 1992; and Lewis, Ricki. (1992). *FDA Consumer*, September 1992. p. 41.

### MINIMAL INFECTIVE DOSES

#### For Some Pathogens and Parasites

<u>Pathogen</u>	<u>Minimal Infective Dose</u>
<i>Ascaris</i>	1-10 eggs
<i>Cryptosporidium</i>	10 cysts
<i>Entamoeba coli</i>	10 cysts
<i>Escherichia coli</i>	1,000,000-100,000,000
<i>Giardia lamblia</i>	10-100 cysts
<i>Hepatitis A virus</i>	1-10 PFU
<i>Salmonella spp</i>	10,000-10,000,000
<i>Shigella spp</i>	10-100
<i>Streptococcus fecalis</i>	10,000,000,000
<i>Vibrio cholerae</i>	1,000

Pathogens have various degrees of *virulence*, which is their potential for causing disease in humans. The minimal infective dose is the number of organisms needed to establish infection.

Source: Bitton, Gabriel. (1994). *Wastewater Microbiology*. New York: Wiley-Liss, Inc., p. 77-78. and *Biocycle*. September

Also refer to *EcoSan/gtz Technology Review publication "Urine diversion dehydration toilets" (Draft version 2 December 2009) - Further Reading (Muench 2009) and also "Urine as a liquid Fertilizer in Agricultural Production in the Philippines" by Gensch and Others at:*

<https://www.susana.org/en/knowledge-hub/resources-and-publications/library/details/1168>

## Feces Handling and Application

Before it can be used as a soil additive, feces require more care and consideration than urine. The most important factors for proper feces digestion are, 1) keeping it dry, and 2) maintaining temperature higher than 50°C (125°F). In its completely digested state following pathogen destruction, it should be of a dry powdery appearance. The pathogens that can exist in human feces can be divided into four general categories: *viruses, bacteria, protozoa and worms (helminths)*. (Refer to the *Humanure Handbook* by Joseph Jenkins).

The WHO has developed guidelines on the concept of reducing potential exposure when using excreta, wastewater, and greywater in agriculture as well as aquaculture. This guidelines is available at: [https://www.who.int/water\\_sanitation\\_health/sanitation-waste/wastewater/wastewater-guidelines/en/](https://www.who.int/water_sanitation_health/sanitation-waste/wastewater/wastewater-guidelines/en/)

## **ECOLOGICAL SANITATION TECHNOLOGIES PROS AND CONS**

The following chart provides a pros and cons comparison of the various types of ecological sanitation systems in common use today.

## ECOLOGICAL SANITATION TECHNOLOGIES PROS AND CONS

The Sustainability Requirements shown in Step 4 have priority over this table.

Refer to 'Sanitation Portal' at: [www.akvo.org](http://www.akvo.org) for individual technology details

Sanitation Technology Pros & Cons	Pit Latrine	VIP	Pour Flush Toilet	Fossa Alterna Toilet	Arborloo (use&/or disposal)	UDDT or EcoSan Toilet	Compost Toilet	Pour Flush Single or Double Latrines	Twin Pits - Pour Flush Toilet	Septic Tank	Anaerobic Reactor (Collect, Store & Treat)	Biogas Reactor Digester
Constant Water Source Required	N	N	Y	N	Y/N	N	Y/N	Y	Y	Y	Y	N
Local Materials Usability	Y	Y	Y	Y	Y	Y	N	Y	Y/N	Y	Y	Y
Capital & Operating Costs	L	L	L	M	L	L	M	L	M	L/M	M	M
All users Suitability	Y	Y	Y	Y	Y	Y	Y	Y	Y	Y	Y	Y
Odors & Flies	Y	N3	N	Y/N1	N	Y	N2	N	Y/N	N	N	N
Small Land Area	Y	Y	N	Y	Y	Y	Y	N	Y	Y	Y	Y3
Excreta Pile visible	Y	Y	N	N	Y	Y/N	N	N	N	N	N	Y
Is Management Education Required	Y	Y	N	Y	Y	Y	Y	Y	Y	Y/N	Y	Y
Secondary Sludge Treatment required	Y	Y	N	N	N	N	N	N	N	Y	Y	Y
High Emptying Costs	N	N	N	N	N	N	N	Y4	N	Y	Y5	N
Pathogen Reduction	N	N	N	Y	N	Y	Y	Y6	Y	L	Y6	N
Urine & Feces Manual Removal	Y	Y	N	Y	N	Y	Y7	Y8	Y9	N	N	N10

Table Indicators Notes: Y=Yes, N=No, L=Low, M=Moderate; N1 Significant reduction compared to pits without water seals; N2 Correct use is necessary; N3 Significant reduction compared to non-ventilated pits; Y3 Underground construction allows for smaller units to be installed on building roofs; Y4 Capital & emptying costs are affected by depth of single unit pits. Double unit emptying costs lower if self-emptied; Y5 Requires truck vacuum system; Y6 Low reduction in pathogens, solids, organics and BOD; Y7 Compost is safe to handle & remove when correctly managed. Leachate will require secondary treatment and appropriate discharge; Y8 fecal material from double pit system has potential to be used as soil conditioner; Y9 Excavation of humus is easier than fecal sludge and has potential for use as soil conditioner; N10 Digested sludge & effluent requires further treatment before using as a soil conditioner.



# LINKS TO HELPFUL SANITATION TECHNOLOGY WEBSITES

## Sanitation Guidelines

WHO sanitation guidelines and fact sheets about specific technologies:

[https://www.who.int/water\\_sanitation\\_health/sanitation-waste/sanitation/sanitation-guidelines/en/](https://www.who.int/water_sanitation_health/sanitation-waste/sanitation/sanitation-guidelines/en/)

WHO wastewater guidelines: [https://www.who.int/water\\_sanitation\\_health/sanitation-waste/wastewater/en/](https://www.who.int/water_sanitation_health/sanitation-waste/wastewater/en/)

Sanitation Technology Options: [http://www.susana.org/\\_resources/documents/default/2-1433-booklet5technologyoptionspdfanlage.pdf](http://www.susana.org/_resources/documents/default/2-1433-booklet5technologyoptionspdfanlage.pdf)

Sanitation Technology Options: [http://www.susana.org/\\_resources/documents/default/2-931-sani-tech-options-2010.pdf](http://www.susana.org/_resources/documents/default/2-931-sani-tech-options-2010.pdf)

## Dry Sanitation Technical Websites

<b>Primary Treatment</b>	<b>Detailed Reports Available At:</b>
Single & Double Ventilated Improved Pit (VIP) Latrine. Low sustainability without ongoing maintenance.	<a href="https://akvopedia.org/wiki/Single_Ventilated_Improved_Pit">https://akvopedia.org/wiki/Single_Ventilated_Improved_Pit</a> <a href="https://akvopedia.org/wiki/Double_Ventilated_Improved_Pit">https://akvopedia.org/wiki/Double_Ventilated_Improved_Pit</a> <a href="http://practicalaction.org/ventilated-improved-pit-latrine">http://practicalaction.org/ventilated-improved-pit-latrine</a> <a href="http://www.youtube.com/watch?v=n4yfAyhiV74">http://www.youtube.com/watch?v=n4yfAyhiV74</a> <a href="http://www.youtube.com/watch?v=XMUTVD4IQ8s&amp;feature=endscreen&amp;NR=1">http://www.youtube.com/watch?v=XMUTVD4IQ8s&amp;feature=endscreen&amp;NR=1</a>
Arborloo (treatment of full VIP Latrine Pit). High sustainability due to planting tree over waste pit.	<a href="https://akvopedia.org/wiki/Fill_and_Cover_-_Arborloo">https://akvopedia.org/wiki/Fill_and_Cover_-_Arborloo</a> <a href="http://aquamor.info/arborloo.html">http://aquamor.info/arborloo.html</a> <a href="https://www.ircwash.org/sites/default/files/leapps_information_2008-03_ecosan_-_how_to_build_arborloo_fossa_alterna_june08.pdf">https://www.ircwash.org/sites/default/files/leapps_information_2008-03_ecosan_-_how_to_build_arborloo_fossa_alterna_june08.pdf</a> <a href="https://www.susana.org/en/knowledge-hub/resources-and-publications/library/details/86">https://www.susana.org/en/knowledge-hub/resources-and-publications/library/details/86</a>
Fossa Alterna (similar to dry double pit technology).	<a href="https://akvopedia.org/wiki/Fossa_Alterna">https://akvopedia.org/wiki/Fossa_Alterna</a> <a href="https://www.susana.org/en/knowledge-hub/resources-and-publications/case-studies/details/88">https://www.susana.org/en/knowledge-hub/resources-and-publications/case-studies/details/88</a> <a href="http://www.clean-water-for-laymen.com/pit-latrine.html">http://www.clean-water-for-laymen.com/pit-latrine.html</a>
Urine Separated (Single or Double) Dehydration Vaults (EcoSan or Vietnamese Double Vaults). Very sustainable due to effective treatment of waste.	<a href="https://akvopedia.org/wiki/Dehydration_Vaults">https://akvopedia.org/wiki/Dehydration_Vaults</a> <a href="http://www.youtube.com/watch?v=YV-1To9DkJQ&amp;feature=youtu.be">http://www.youtube.com/watch?v=YV-1To9DkJQ&amp;feature=youtu.be</a> <a href="http://www.susana.org/_resources/documents/default/2-1195-en-susana-cs-kenya-schools-uddts-24nov2011.pdf">http://www.susana.org/_resources/documents/default/2-1195-en-susana-cs-kenya-schools-uddts-24nov2011.pdf</a> <a href="https://akvopedia.org/wiki/Urine_Storage_Tank_/Container">https://akvopedia.org/wiki/Urine_Storage_Tank_/Container</a> -
Composting Toilets. Very sustainable if waste is managed correctly.	<a href="http://practicalaction.org/compost-toilets-1">http://practicalaction.org/compost-toilets-1</a> <a href="https://akvopedia.org/wiki/Composting_Chamber">https://akvopedia.org/wiki/Composting_Chamber</a> <a href="https://ocw.un-ihc.org/pluginfile.php/651/mod_folder/content/0/2_gtz2009-en-technology-review-composting-toilets.pdf?forcedownload=1">https://ocw.un-ihc.org/pluginfile.php/651/mod_folder/content/0/2_gtz2009-en-technology-review-composting-toilets.pdf?forcedownload=1</a>

## Pour Flush Sanitation Technical Websites

VIP Latrines	<a href="https://akvopedia.org/wiki/Urine_Diverting_Dry_Toilet">https://akvopedia.org/wiki/Urine_Diverting_Dry_Toilet</a> <a href="https://akvopedia.org/wiki/Pour_Flush_Toilet">https://akvopedia.org/wiki/Pour_Flush_Toilet</a> <a href="https://akvopedia.org/wiki/Application_of_Stored_Urine">https://akvopedia.org/wiki/Application_of_Stored_Urine</a>
Twin Pits for Pour Flush.	<a href="https://akvopedia.org/wiki/Twin_Pits_for_Pour_Flush">https://akvopedia.org/wiki/Twin_Pits_for_Pour_Flush</a>
Septic Tank and Leach Field.	<a href="https://akvopedia.org/wiki/Septic_Tank">https://akvopedia.org/wiki/Septic_Tank</a> <a href="https://akvopedia.org/wiki/Leach_Field">https://akvopedia.org/wiki/Leach_Field</a>
Biogas Digester. Very sustainable.	<a href="https://akvopedia.org/wiki/Biogas_Reactor">https://akvopedia.org/wiki/Biogas_Reactor</a> <a href="https://www.susana.org/resources/documents/default/2-131-en-susana-cs-kenya-naivasha-biogas-public-toilet-final-2009.pdf">https://www.susana.org/resources/documents/default/2-131-en-susana-cs-kenya-naivasha-biogas-public-toilet-final-2009.pdf</a> ; <a href="https://akvopedia.org/wiki/Biogas_Combustion">https://akvopedia.org/wiki/Biogas_Combustion</a> <a href="https://www.susana.org/en/knowledge-hub/resources-and-publications/library/details/1168">https://www.susana.org/en/knowledge-hub/resources-and-publications/library/details/1168</a>

## CHECKLIST FOR INSTALLATION OF SANITATION FACILITIES

Before selecting a sanitation technology to install, a number of things have to be undertaken because the incorrect technology may not be accepted or maintained, and not used; or the environment, including an area's water supply, may become polluted, leading to the spread of disease. Due to the lack, or anticipated lack, of water in many developing countries, on-site Ecological Sanitation Technologies are being adopted for individual housing, neighbourhoods, schools and community facilities.

An analysis needs to be undertaken to ascertain what the local population currently does regarding sanitation. Do people have toilets of any kind, and if they do what type are they? Do they openly defecate and urinate wherever it is most convenient, or only in a defined area set aside for this purpose? Once cultural issues are determined that might affect technology selection, environmental conditions must be evaluated to narrow down the alternative technologies available.

Answering the following questions will help decide the most suitable technology to install.

### Planning Understanding the Area/Community

Define the area's size (km<sup>2</sup>) and its population size. \_\_\_\_\_

Are there any toilets in the area? \_\_\_\_\_

Are there any toilets in the community that people have access to? \_\_\_\_\_

Are there any community toilets in the area? \_\_\_\_\_

What are the existing sanitation practices? \_\_\_\_\_

Is open defecation practiced anywhere in the community? \_\_\_\_\_

Is defecation practiced in a defined location? \_\_\_\_\_

Are there any school toilets in the area? \_\_\_\_\_

Do all schools have toilets for their pupils? \_\_\_\_\_

What type of toilet has been installed at the school? \_\_\_\_\_

Is water available for the toilets at all times? \_\_\_\_\_

Are urinals provided and in what shape and what materials? \_\_\_\_\_

What soils are in the area where sanitation is required? \_\_\_\_\_

Is rock in the area where the sanitation system is to be installed? \_\_\_\_\_

Has the government undertaken any investigation for sanitation to be implemented? \_\_\_\_\_

Has the government directed construction of any sanitation? \_\_\_\_\_

Has the government listed any particular technology in a policy or publication? \_\_\_\_\_

### Implementing a Program through Education

Why is it necessary to install toilets when local people have openly defecated for centuries?

Are there any illnesses or diseases caused through the lack of sanitation facilities? \_\_\_\_\_

Can we reduce these diseases quickly without installing sanitation "hardware" (such as implanting simple hygiene practices)? \_\_\_\_\_

Are school children affected? \_\_\_\_\_

Are females more affected than males with the lack of toilets? How? \_\_\_\_\_

What tools can we use to educate aging people to install and use toilets? \_\_\_\_\_

Should a CLTS program (Community) and/or a SLTS (School) be undertaken? \_\_\_\_\_

How do I find out about CLTS? \_\_\_\_\_

Is CLTS a specialist Job, and if so, where can a specialist be found? \_\_\_\_\_

Can Rotarians in my club be trained to be a CLTS specialist? \_\_\_\_\_

Are there alternative ways of engaging the local population? \_\_\_\_\_

### **Environmental Considerations - Water Availability and Use**

Does the area have a reliable water supply? \_\_\_\_\_

What is the source of the water supply? \_\_\_\_\_

What systems (rainwater harvesting, water well, spring water) are used to maintain the water supply? \_\_\_\_\_

Is water required to flush a toilet pan, perform anal cleansing or wash hands? \_\_\_\_\_

### **Environmental Considerations - Flooding and its Effect on Technologies**

Which technologies are suitable for areas covered by flood waters? \_\_\_\_\_

Which technologies are suitable for areas not covered with flood waters? \_\_\_\_\_

What is the depth of the water table at the end of the wet season? \_\_\_\_\_

Which technology do I use in areas with little or no water? \_\_\_\_\_

Are there any technologies available which do not use water? \_\_\_\_\_

Where there is little or no water how is the human waste treated? \_\_\_\_\_

### **Selecting the Ecological Sanitation Technology**

What are Ecological Sanitation Technologies? \_\_\_\_\_

What are these technologies called? \_\_\_\_\_

Which technology do I use in dry arid areas? \_\_\_\_\_

Which technology do I use where a good water supply will continue to be available? \_\_\_\_\_

What technologies do I use in schools and hospitals/clinics? \_\_\_\_\_

Is there more to it than "push the button and forget?" \_\_\_\_\_

Human waste comprises urine and feces. Does this have any value to the community? \_\_\_\_\_

Is there a history of using human wastes to enhance the production of food in the community? \_\_\_\_\_

Who pays to construct new sanitation installations? \_\_\_\_\_

Who pays to operate and maintain these sanitation installations? \_\_\_\_\_

Should they be donated, or should we work out a way to install them at the expense of the recipient? \_\_\_\_\_

Can trades/jobs be developed for building sanitation systems in the region and providing operations and maintenance of these systems in the region? \_\_\_\_\_